

## ASTRO-PHYSICS

### 105 mm f6 TRAVELER EDT REFRACTOR (4.1" aperture)

Imagine a refractor with a 105mm (4.1") aperture, focal ratio of f6, in a tube assembly that has an overall length of 19"! The 105 Traveler EDT is the culmination of years of optical research aimed at developing a very fast and portable telescope that will allow you to enjoy sharp, high contrast images wherever you go. The 105 EDT has a fully machined tube assembly with a permanently aligned lens cell. Its construction is extremely rugged to allow it to withstand all the handling that is typical of airline travel. The lens uses a special new Super ED glass (E.D. stands for extra low dispersion,  $V_d > 90$ ) that allows colorfree performance at the F6 focal ratio. Images of stars and planets are presented in their natural colors, and daytime objects appear sharp and contrasty without annoying purple fringes.

The optical design of the 105mm EDT objective is identical to the StarFire EDT refractors. It consists of a positive element of Super E.D. glass surrounded by two matching hard crown meniscus lenses. The two outer elements are chosen so that the overall combination is free of coma, spherical aberration and other higher order aberrations. All surfaces are spherical, which results in a very smooth overall figure. Under steady viewing conditions, you will see a hard white Airy disc at focus surrounded by the first diffraction ring. Inside and outside of focus, you will see an evenly illuminated, expanded disc with concentric Fresnel rings, with the outermost ring brighter and wider than the rest. Besides having ideal optical characteristics, the EDT objective is significantly lighter than our older designs and the settling down time is also improved. On most nights, the lens is ready to go in 10 to 15 minutes and, even in sub-freezing conditions, it rarely takes more than 45 minutes to stabilize.

#### PERFORMANCE

The 105 Traveler EDT is an awesome performer both at night and during the daytime using powers as low as 12x or as high as 400x. It has 36% more light grasp than a 3.5" Maksutov and 10% more light grasp than a 4" refractor. During the daytime, delicate detail and vivid colors of flowers and wildlife are a true joy to observe. During the night, the high light transmission of the extremely pure optical glass becomes immediately apparent. With a 2" widefield eyepiece we have seen the entire Veil Nebula, including the very faint inner region, all in one eyepiece field of view. The North American Nebula region is so bright and clear, it looks like a deep sky astrophoto. Pop in a high power eyepiece and you will be rewarded with truly stunning views of the Moon and planets. The view of Jupiter will amaze you with sharp views of the bands, festoons, white ovals and the great Red Spot. This scope shows detail on Saturn and Mars that rival views in much larger instruments.

The Traveler is a fabulous astrograph. With a Pentax 6x7cm camera, you can capture 5.6 x 6.6 degrees of stunning star fields, clusters and nebulas at f6! If a faster focal ratio in a 35mm format is desired, use our 2.7" telecompressor for f4, or a 2x Barlow for f12 exposures.

Whether traveling to exotic eclipse locations, your favorite camping spot, bird watching expeditions or just into your backyard; this little gem will provide you with hours of observing pleasure.



105mm Traveler EDT, Prototype 400 Mount, and Tripod

#### MECHANICAL CONSTRUCTION

The mechanical construction of the Traveler makes this scope completely trouble free and keeps the optics permanently aligned. Its gorgeous tube assembly is precision machined in our shop with the most modern CNC equipment available. There are no fragile die casts in this telescope. Our expert machinist transforms solid, aircraft quality aluminum into a fully baffled tube assembly with no less than 12 knife edge baffles in the focuser drawtube alone. We have endeavored to achieve the highest absorption of stray light possible to give you the maximum contrast. The black anodized exterior finish of the tube and dewcap will retain its deep, lustrous beauty for many years. You will appreciate the unique design and fine craftsmanship of this telescope.

Our superb Astro-Physics focuser is a very finely crafted unit with several unique features. The components are machined to extremely high tolerances assuring that there is no wiggle between the drawtube and housing. More than a dozen knife-edge baffles are machined into the wall of the drawtube and painted flat black in order to maximize contrast by essentially eliminating any internal reflections. The inside diameter (I.D.) of the drawtube is 2.7" which allows the avid astrophotographer to use a medium format camera to capture images in a 6x7cm format with minimal vignetting. 2" inch and 1.25" adapters allow you to use standard accessories. Recessed brass locking rings are installed at each thumbscrew location. As you tighten each thumbscrew, the brass locking ring clamps onto the part that has been inserted. Consequently, your focuser drawtube, 2" accessories and 1.25" accessories are held securely in place. This is particularly important considering the heavy and expensive accessories that you may use. As an added advantage, the brass will not mar the surface of your accessories.

We invite you to compare the optical performance and mechanical construction of any other scope of comparable size on the market today. You will find that the Astro-Physics 105 Traveler EDT is the finest, most versatile scope of its size.

# 105mm F6 TRAVELER EDT SPOT DIAGRAMS FOR VISUAL WAVELENGTHS, .5 DEG FIELD

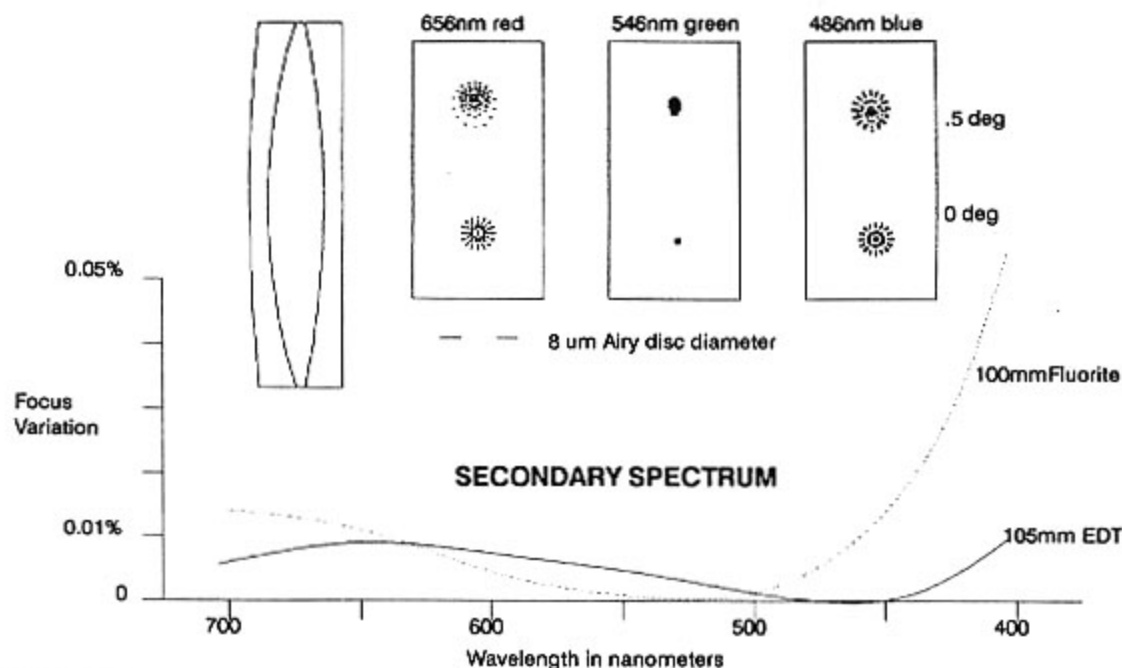

## SPECIFICATIONS:

Color correction:	Less than .01% focus variation from 706nm to 405nm.
Clear aperture :	105mm (4.13")
Focal Length :	610mm (24")
Resolution :	1.1 arc seconds
Magnification range :	12x to 400x
Tube assembly:	Black anodized, 19" aluminum tube, fully baffled, permanently aligned cell construction, engraved focuser
Focuser type :	2.7" ID Astro-Physics rack & pinion focuser, 4.5" travel; 2" and 1.25" adapters; 2.5" extension
Telescope Length:	48 cm (19") with dewcap fully retracted
Weight with dewcap:	9 lbs. (4kg)
Carrying case type:	Custom padded bag from Tenba
Case outside dimensions:	21" x 10.8" x 7" (53cm x 27cm x 18cm)
Weight of empty case:	3.5 lbs. (1.6 kg)
35mm prime focus field:	2.3 x 3.2 degrees @ f6
35mm Telecompressor field:	3.3 x 4.8 degrees @ f4
35mm field with 2x Barlow:	1.1 x 1.6 degrees @ f12
6cm x 7cm prime focus field:	5.6 x 6.6 degrees @ f6

Specifications are subject to change without notice.

## FEATURES OF THE OPTICS

- Very high corrections of spherical and chromatic aberrations
- Visual and photographic focus is identical, eliminating the need for light absorbing filters
- Clear, colorfree glass types result in brighter, more contrasty images
- Stunning lunar / planetary and deep sky views
- Ideal for 35mm and medium format deep sky astrophotography
- High resolution optics are a good match for fine grained Technical Pan emulsions.

## FEATURES OF THE TUBE ASSEMBLY

- Felt lined dewcap slides over cell for storage
- Fully baffled tube and focuser assures highest contrast
- Giant 2.7" focuser allows coverage of 6 x 7 formats
- 2" and 1.25" adapters with brass locking ring, 2.5" extension
- Beautifully machined parts with lustrous black anodize
- Aluminum lens cover to protect against dust
- Sturdy padded carrying case will fit in airline overhead storage compartments. Case has location to insert padlock

## SUGGESTIONS

400 German Equatorial Mount with or without Dual Axis Drive  
This portable mount is perfect for visual and photographic studies in either the Northern or Southern Hemispheres.

### Diagonals and Binocular Viewers:

Prism diagonals have aberrations which degrade image quality. Since this is especially noticeable in scopes with fast focal ratios, we recommend the 2" Precision Mirror Diagonal for the Traveler. If you use a binocular viewer (which has prisms), place a barlow between the focuser and binocular viewer.

### Eyeieces:

Plossls, Orthoscopes, and Widefield eyepieces show sharp images only in the center of the field. These are fine as long as you realize this limitation. If you object to astigmatic images at the edge of the field, we recommend TeleVue Nagler and Panoptic eyepieces. These oculars have the best flat field images and will bring out the most in your 105 Traveler EDT. Use our 2" (2x) Barlow to double your magnification.

	magnification	actual field of view	exit pupil
55mm Plossl	11x	4.6deg	9.6mm
35mm Panoptic	18x	3.8 deg	5.3mm
22mm Panoptic	28x	2.4 deg	3.8mm
13mm Nagler	48x	1.7 deg	2.2mm
9mm Nagler	70x	1.2 deg	1.5mm
7mm Nagler	90x	0.9 deg	1.2mm
4.8mm Nagler	131x	0.6 deg	0.8mm

A 55mm Plossl can also serve as your finder.

Please refer to the brochure for descriptions of these items and additional accessories.

## ASTRO-PHYSICS

### 130mm f8 STARFIRE EDT REFRACTOR (5.1" aperture)

The 130mm StarFire EDT is a very portable, lightweight refractor with a Super E.D. triplet objective that is highly corrected for false color (chromatic aberration). The color error is less than 0.01% from 706nm to 405nm, compared to a 2 element Fluorite apochromat with 0.05%, and a Doublet Achromat with 0.45% color error over the same spectral range. In an age when Fluorite is being hyped as the best lens material for fast refractors, it is significant that Astro-Physics has developed a non-Fluorite objective with 5 times better chromatic aberration at a fraction of the cost of Fluorite. Super E.D. glass (E.D. stands for extra low dispersion,  $V_d > 90$ ) is a real glass, not a crystal like Fluorite. E.D. is a much harder, less fragile material with a much lower expansion coefficient than Fluorite. Unlike Fluorite, E.D. glass is not affected by atmospheric contaminants and acids. It is for these reasons that all the world's major camera manufacturers are incorporating E.D. glass in their best lenses.

The extremely high color correction of the Super EDT design allows the construction of a relatively short focus objective that is superior to long focus achromats in contrast and definition of subtle planetary detail. The EDT lens is also perfectly matched to the characteristics of the fine grained Technical Pan emulsions which have their peak sensitivity at 405nm. With our matching accessories you can create impressive astrophotos on 35mm and 6x7cm film formats.

The optical design of the 130mm EDT objective consists of a positive element of E.D. glass surrounded by two matching hard crown meniscus lenses. The two outer elements are chosen so that the overall combination is free of coma, spherical aberration and other higher order aberrations. All surfaces are spherical, which results in a very smooth overall figure. Under steady viewing conditions, you will see a hard white Airy disc at focus surrounded by the first diffraction ring. Inside and outside of focus you will see an evenly illuminated, expanded disc with concentric Fresnel rings, with the outermost ring brighter and wider than the rest.

#### MECHANICAL CONSTRUCTION

We have incorporated several significant improvements to the tube assembly to make it easier to transport and set up in the field. The dewcap slides over the lens cell for more compact storage. An aluminum dust cover protects the optical surface when not in use, and a foam fitted carrying case will help retain the beauty of your tube assembly for years to come. The tube is fully baffled, painted with light absorbing flat black and features our adjustable push-pull cell.

Our superb Astro-Physics focuser is a very finely crafted unit with several unique features. The components are machined on our own CNC to extremely high tolerances assuring that there is no wiggle between the drawtube and housing. More than a dozen knife-edge baffles are machined into the wall of the drawtube and painted flat black in order to maximize contrast by essentially eliminating any internal reflections. The inside diameter (I.D.) of the drawtube is 2.7" which allows the avid astrophotographer to use a medium format camera to capture images in a 6x7cm format with minimal vignetting. Two inch and 1.25" adapters allow you to use standard accessories. Recessed brass locking rings are installed at each thumbscrew location. As you tighten each thumbscrew, the brass locking ring clamps onto the part that has been inserted. Consequently, your focuser drawtube, 2" accessories and 1.25" accessories are held securely in place. This is particularly important considering the heavy and expensive accessories that you may use. As an added advantage, the brass will not mar the surface of your accessories.



130mm StarFire EDT, 600 E German Equatorial, 48" Pier

#### PERFORMANCE

The 130mm StarFire EDT was designed to be a very compact, very portable refractor that will set up in minutes, settle down quickly and provide hours of enjoyment. It has 67% more light grasp than a 4" aperture, yet it is not much larger than many of the 4" refractors on the market today. Like the classical 5" f15 refractor, this instrument is fully capable of superb planetary performance, yet is only half as long. Amateurs have reported seeing the elusive Enke division on Saturn with our 5 inch StarFire. With a 35mm widefield eyepiece, we have observed the Double Cluster in Perseus. The stars were so sharp, they seemed to have no dimensions- pinpricks would have been too crude a description for their appearance. Take advantage of the many hours of daylight to observe fascinating detail on the surface of the sun.

The 130EDT optical design is ideal for astrophotography with small and medium format cameras. The wide field coverage in the 6x7 photographic format will record gorgeous images of a wide variety of objects such as the Andromeda galaxy and Lagoon and Trifid Nebulas. The negatives contain so much finely resolved detail that you can enlarge a small portion to feature one particular aspect of the object, i.e. the gulf of Mexico portion of the North American Nebula. One of the finest solar eclipse photographs of the corona was taken with the 130EDT StarFire refractor in July 1991. This photo and other deep sky photos that were taken with our 5" f8 StarFire have appeared on the cover of numerous astronomical publications around the world.

The 130mm StarFire EDT is a refractor with unsurpassed image quality, yet it is so handy and versatile that you will use it often.

## 130mm f8 StarFire EDT SPOT DIAGRAMS FOR VISUAL WAVELENGTHS, .5 DEG FIELD

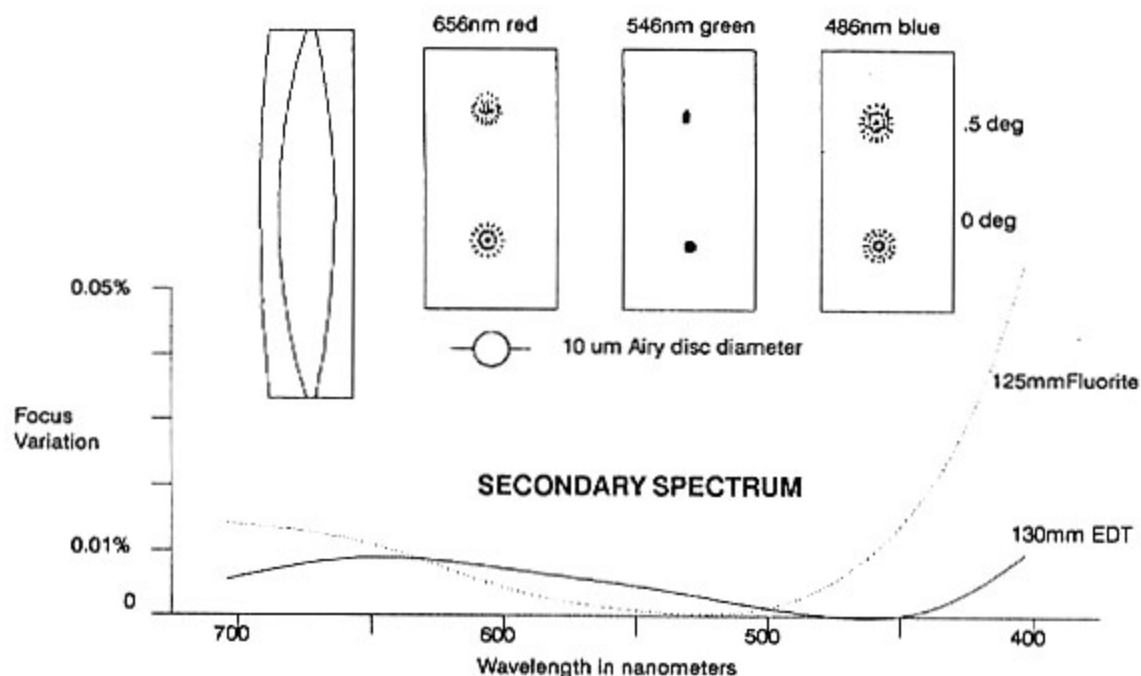

### SPECIFICATIONS

Color correction:	Less than .01% focus variation from 706nm to 405nm.
Clear aperture:	130mm (5.12")
Focal Length:	1016mm (40")
Resolution:	0.87 arc seconds
Magnification range:	18x to 500x
Tube assembly:	White, 5.5" aluminum tube, baffled, flat black interior, engraved push-pull lens cell
Focuser type:	2.7" ID Astro-Physics rack & pinion focuser, 4.5" travel; 2" and 1.25" adapters; 2.5" extension
Telescope Length:	914mm (36") with dewcap fully retracted
Weight with dewcap:	16 lbs. (7.3kg)
Carrying case type:	Wood case with grey vinyl covering and foam lined interior
Case outside dimensions:	40.5"x9"x9" (103cmx23cmx23cm)
Weight of empty case:	15.5 lbs. (7.8kg)
35mm prime focus field:	1.3 x 2.0 degrees @ f8
35mm Telecompressor field:	2.0 x 3.0 degrees @ f5.3
35mm field with 2x Barlow:	0.7 x 1.0 degrees @ f16
6cm x 7cm prime focus field:	3.4 x 4.0 degrees @ f8

Specifications subject to change without notice.

### FEATURES OF THE OPTICS

- Very high corrections of spherical and chromatic aberrations
- Textbook perfect diffraction patterns
- Visual and photographic focus is identical, eliminating the need for light absorbing filters
- Clear, colorfree glass types result in brighter, more contrasty images
- Stunning lunar / planetary and deep sky views
- Ideal for 35mm and medium format deep sky astrophotography
- High resolution optics are a good match for fine grained Technical Pan emulsions.

### FEATURES OF THE TUBE ASSEMBLY

- Felt lined dewcap slides over cell for storage
- Fully baffled tube and focuser assures highest contrast
- Giant 2.7" focuser allows coverage of 6 x 7 formats
- 2" and 1.25" adapters with brass locking ring, 2.5" extension
- Beautifully machined parts and expertly finished in hard polyurethane paint or black anodized
- Aluminum lens cover to protect against dust
- Sturdy foam padded carrying case

### SUGGESTIONS

Portable mount for visual and photographic studies  
400 German Equatorial Mount with or without Dual Axis Drive

Portable mount for extensive astrophotography  
600E German Equatorial Mounts with Dual Axis Drive

### Eyepieces:

Plossls, Orthoscopes, and Widefield eyepieces show sharp images only in the center of the field. These are fine as long as you realize this limitation. If you object to astigmatic images at the edge of the field, we recommend TeleVue Nagler and Panoptic eyepieces. These oculars have the best flat field images and will bring out the most in your 130 StarFire EDT. Use our 2x (2") Barlow to double your magnification.

	magnification	actual field of view	exit pupil
55mm Plossl	18x	2.8 deg	7.2mm
35mm Panoptic	30x	2.3 deg	4.3mm
22mm Panoptic	47x	1.5 deg	2.8mm
13mm Nagler	80x	1.0 deg	1.6mm
9mm Nagler	115x	0.7 deg	1.1mm
7mm Nagler	148x	0.6 deg	0.9mm
4.8mm Nagler	217x	0.4 deg	0.6mm

Please refer to the brochure for descriptions of these items and additional accessories.

## ASTRO-PHYSICS

### 155 mm f9 STARFIRE EDT REFRACTOR (6.1" aperture)

The 155mm f9 StarFire EDT is a high performance instrument with a Super E.D. triplet objective that is highly corrected for false color (chromatic aberration). The chromatic aberration is less than 0.01% from 706 nm to 405 nm compared to a 2 element Fluorite apochromat with 0.05% and a Doublet Achromat with 0.46% over the same spectral range. In an age when Fluorite is being hyped as the best lens material for fast refractors, it is significant that Astro-Physics has developed a non-Fluorite objective with 5 times better chromatic aberration at a fraction of the cost of Fluorite. Super E.D. glass (E.D. stands for extra low dispersion,  $V_d > 90$ ) is a real glass, not a crystal like Fluorite. E.D. is a much harder, less fragile material with a much lower expansion coefficient than Fluorite. Unlike Fluorite, E.D. glass is not affected by atmospheric contaminants and acids. It is for these reasons that the world's major camera makers are incorporating E.D. glass in their best lenses.

The extremely high color correction of the Super EDT design allows the construction of a relatively short focus objective that is superior to long focus achromats in contrast and definition of subtle planetary detail. The EDT lens is also perfectly matched to the characteristics of the fine grained Technical Pan emulsions which have their peak sensitivity at 405nm. With our matching accessories you can create impressive astrophotos on 35mm and 6x7 film formats.

The optical design of the 155mm EDT objective consists of a positive element of E.D. glass surrounded by two matching hard crown meniscus lenses. The two outer elements are chosen so that the overall combination is free of coma, spherical aberration and other higher order aberrations. All surfaces are spherical, which results in a very smooth overall figure. Under steady viewing conditions, you will see a hard white Airy disc at focus surrounded by the first diffraction ring. Inside and outside of focus you will see an evenly illuminated, expanded disc with concentric Fresnel rings, with the outermost ring brighter and wider than the rest. Besides having ideal optical characteristics, the EDT objective is significantly lighter than our older designs and the settling down time is also improved.

#### MECHANICAL CONSTRUCTION

We have incorporated several significant improvements to the tube assembly to make it easier to transport and set up in the field. The dewcap slides over the lens cell for more compact storage. An aluminum dust cover protects the optical surface when not in use, and a foam fitted carrying case will help retain the beauty of your tube assembly for years to come. The tube is fully baffled, painted with light absorbing flat black and features our adjustable push-pull cell.

Our superb Astro-Physics focuser is a very finely crafted unit with several unique features. The components are machined on our own CNC to extremely high tolerances assuring that there is no wiggle between the drawtube and housing. More than a dozen knife-edge baffles are machined into the wall of the drawtube and painted flat black in order to maximize contrast by essentially eliminating any internal reflections. The inside diameter (I.D.) of the drawtube is 2.7" which allows the avid astrophotographer to use a medium format camera to capture images in a 6x7cm format with minimal vignetting. Two inch and 1.25" adapters allow you to use standard accessories. Recessed brass locking rings are installed at each thumbscrew location. As you tighten each thumbscrew, the brass locking ring clamps onto the part that has been inserted. Consequently, your focuser drawtube, 2" accessories and 1.25" accessories are held securely in place. This is particularly important considering the heavy and expensive accessories that you may use. As an added advantage, the brass will not mar the surface of your accessories.



155mm StarFire EDT, 600 E mount, 48" Pier

#### PERFORMANCE

The 155mm StarFire EDT was designed on a challenge to deliver the absolute highest possible image quality for lunar/planetary observing while still remaining a truly portable instrument. The result is not only a fine planetary telescope, but also a superb deep sky instrument with unlimited photographic possibilities. It has 38% more light grasp than a 130mm (5.1") aperture and 110% more than a 105mm (4.1") aperture. Planetary contrast is crisp and sharp showing exquisite detail and natural coloration of surface features. On nights of good seeing, it will be a challenge to draw all of the lunar or planetary detail that you observe. Double stars at the theoretical limit of 0.74 arc second are split cleanly. Star clusters appear as diamond dust sharply defined against black velvet. Incredible solar granulation, sunspots with feathery faculae and the fine filaments of prominences are revealed in our H-alpha Solar System. The 155mm StarFire EDT is a truly versatile instrument that will allow the advanced amateur to explore many aspects of astronomy and a renew a wonder in the vastness and beauty of the universe.

You will be very pleased with the mechanical construction of this beautiful refractor and the way it performs optically will delight you.

## 155mm F9 STARFIRE EDT SPOT DIAGRAMS FOR VISUAL WAVELENGTHS, .5 DEG FIELD

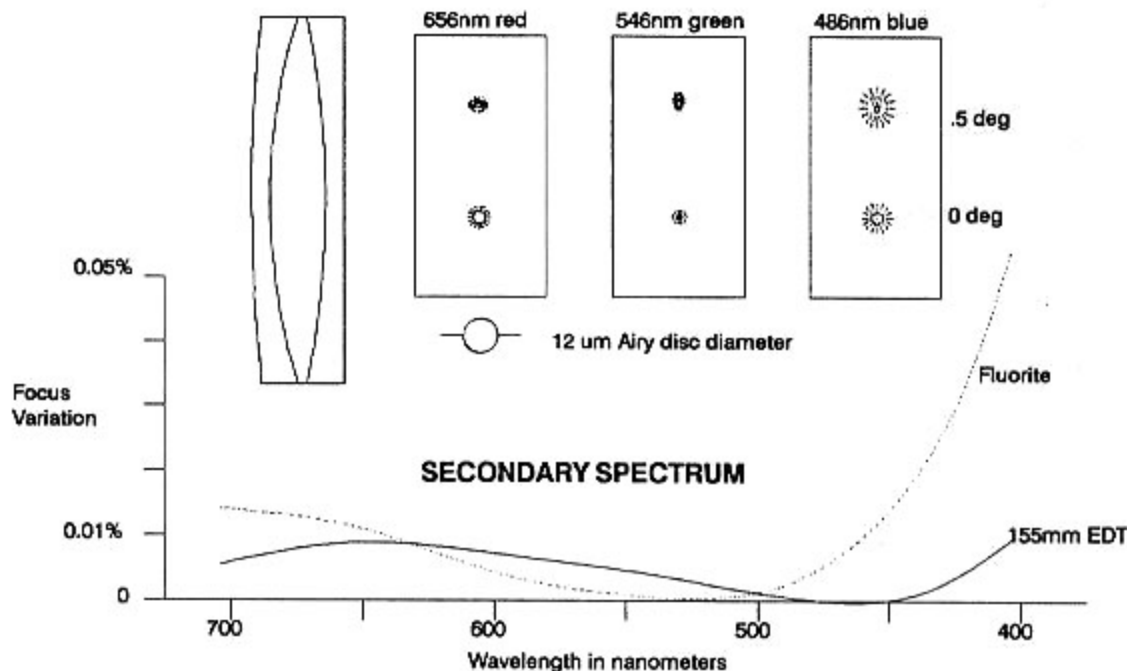

### SPECIFICATIONS:

Color correction:	Less than .01% focus variation from 706nm to 405nm.
Clear aperture:	155mm (6.1")
Focal Length:	1395mm (55")
Resolution :	0.74 arc seconds
Magnification range:	25x to 600x
Tube assembly:	White, 6.5" aluminum tube, baffled, flat black interior, engraved retaining ring, push-pull lens cell
Focuser type:	2.7" ID Astro-Physics rack & pinion focuser, 4.5" travel; 2" and 1.25" adapters; 2.5" extension
Telescope Length:	1270mm (50") with dewcap fully retracted
Weight with dewcap:	10.5 kg (23 lbs)
Carrying case type:	Wood case with grey vinyl covering and foam lined interior
Case outside dimensions:	56.5"x9.8"x10.3" (144cmx25cmx26cm)
Weight of empty case:	22 lbs. (10kg)
35mm prime focus field:	1.0 x 1.5 degrees @ f9
35mm Telecompressor field:	1.5 x 2.2 degrees @ f6
35mm field with 2x Barlow:	0.5 x 0.7 degrees @ f18
6cm x 7cm Prime focus field:	2.5 x 2.9 degrees @ f9

Specifications subject to change without notice.

### FEATURES OF THE OPTICS

- Very high corrections of spherical and chromatic aberrations
- Visual and photographic focus is identical, eliminating the need for light absorbing filters
- Clear, colorfree glass types result in brighter, more contrasty images
- Stunning lunar / planetary and deep sky views
- Ideal for 35mm and medium format deep sky astrophotography
- High resolution optics are a great match for fine grained Technical Pan emulsions.

### FEATURES OF THE TUBE ASSEMBLY

- Felt lined dewcap slides over cell for storage
- Fully baffled tube and focuser assures highest contrast
- Giant 2.7" focuser allows coverage of 6 x 7 formats
- 2" and 1.25" adapters with brass locking ring, 2.5" extension
- Beautifully machined parts, expertly finished in hard polyurethane paint or black anodized
- Aluminum lens cover to protect against dust
- Sturdy foam padded carrying case

### SUGGESTIONS

Portable mount for visual and photographic studies:  
600 E German Equatorial Mount with Dual Axis Drive

Portable mount for extensive astrophotography:  
800 German Equatorial Mount with Dual Axis Drive

### Eyeieces:

Plossls, Orthoscopes, and Widefield eyepieces show sharp images only in the center of the field. These are fine as long as you realize this limitation. If you object to astigmatic images at the edge of the field, we recommend TeleVue Nagler and Panoptic eyepieces. These oculars have the best flat field images and will bring out the most in your 155 StarFire EDT. Use our 2" (2x) barlow to double your magnification.

	magnification	actual field of view	exit pupil
55mm Plossl	25x	2.0 deg	6.2mm
35mm Panoptic	37x	1.8 deg	3.9mm
22mm Panoptic	63x	1.1 deg	2.4mm
13mm Nagler	107x	0.8 deg	1.4mm
9mm Nagler	155x	0.5 deg	1.0mm
7mm Nagler	200x	0.4 deg	0.8mm
4.8mm Nagler	291x	0.3 deg	0.5mm

Please refer to the brochure for descriptions of these items and additional accessories.

## ASTRO-PHYSICS

### 180 mm f9 STARFIRE EDT REFRACTOR (7.1" aperture)

The 180mm f9 StarFire EDT is a high performance instrument with a Super E.D. triplet objective that is highly corrected for false color (chromatic aberration). The chromatic aberration is less than 0.01% from 706 nm to 405 nm compared to a 2 element Fluorite apochromat with 0.05% and a Doublet Achromat with 0.46% over the same spectral range. In an age when Fluorite is being hyped as the best lens material for fast refractors, it is significant that Astro-Physics has developed a non-Fluorite objective with 5 times better chromatic aberration at a fraction of the cost of Fluorite. Super E.D. glass (E.D. stands for extra low dispersion,  $V_d > 90$ ) is a real glass, not a crystal like Fluorite. E.D. is a much harder, less fragile material with a much lower expansion coefficient than Fluorite. Unlike Fluorite, E.D. glass is not affected by atmospheric contaminants and acids. It is for these reasons that the world's major camera makers are incorporating E.D. glass in their best lenses.

The extremely high color correction of the Super EDT design allows the construction of a relatively short focus objective that is superior to long focus achromats in contrast and definition of subtle planetary detail. The EDT lens is also perfectly matched to the characteristics of the fine grained Technical Pan emulsions which have their peak sensitivity at 405nm. With our matching accessories you can create impressive astrophotos on 35mm and 6x7 film formats.

The optical design of the 180mm EDT objective consists of a positive element of E.D. glass surrounded by two matching hard crown meniscus lenses. The two outer elements are chosen so that the overall combination is free of coma, spherical aberration and other higher order aberrations. All surfaces are spherical, which results in a very smooth overall figure. Under steady viewing conditions, you will see a hard white Airy disc at focus surrounded by the first diffraction ring. Inside and outside of focus you will see an evenly illuminated, expanded disc with concentric Fresnel rings, with the outermost ring brighter and wider than the rest.

#### MECHANICAL CONSTRUCTION

We have incorporated several significant improvements to the tube assembly to make it easier to transport and set up in the field. The dewcap slides over the lens cell for more compact storage. An aluminum dust cover protects the optical surface when not in use, and a foam fitted carrying case will help retain the beauty of your tube assembly for years to come. The tube is fully baffled, painted with light absorbing flat black and features our adjustable push-pull cell.

Our superb Astro-Physics focuser is a very finely crafted unit with several unique features. The components are machined on our own CNC to extremely high tolerances assuring that there is no wiggle between the drawtube and housing. More than a dozen knife-edge baffles are machined into the wall of the drawtube and painted flat black in order to maximize contrast by essentially eliminating any internal reflections. The inside diameter (I.D.) of the drawtube is 2.7" which allows the avid astrophotographer to use a medium format camera to capture images in a 6x7cm format with minimal vignetting. Two inch and 1.25" adapters allow you to use standard accessories. Recessed brass locking rings are installed at each thumbscrew location. As you tighten each thumbscrew, the brass locking ring clamps onto the part that has been inserted. Consequently, your focuser drawtube, 2" accessories and 1.25" accessories are held securely in place. This is particularly important considering the heavy and expensive accessories that you may use. As an added advantage, the brass will not mar the surface of your accessories.



180mm StarFire EDT , 800 German Equatorial, 54" Pier

#### PERFORMANCE

The 180mm StarFire EDT was developed with our model 800 German Equatorial Mount to be the largest refractor system that is reasonably portable. It has 36% more light grasp than a 6" refractor and twice the light grasp of a 5" refractor. The planetary performance of the 180 StarFire is breathtaking to say the least. At opposition, Mars reveals so much detail that it is difficult to draw everything that is visible. Deep sky views are bright and contrasty. The high definition optics reveal mottling and detail in nebulae where ordinary telescopes show only fuzzy outlines.

Stunning photographs of M33 reveal spiral arms as sprinklings of fine powdered sugar. H-alpha photographs of the sun's surface taken at full aperture rival anything we have seen from the professional observatories.

The views through your 180 StarFire EDT will draw crowds at star parties. Plan on standing in line to observe through your own scope! You will be very pleased with the mechanical construction of this beautiful refractor and the way it performs optically will delight you.

# 180mm F9 STARFIRE EDT SPOT DIAGRAMS FOR VISUAL WAVELENGTHS, .5 DEG FIELD

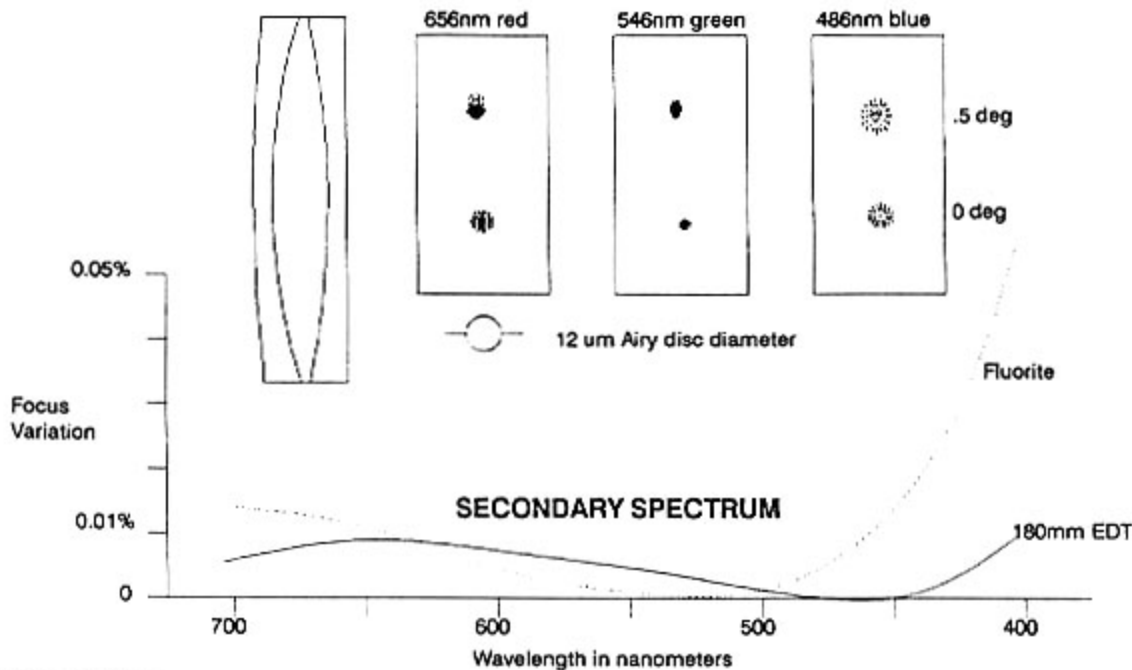

## SPECIFICATIONS:

Color correction:	Less than .01% focus variation from 706nm to 405nm.
Clear aperture:	180mm (7.1")
Focal Length:	1620mm (64")
Resolution:	0.64 arc seconds
Magnification range:	30x to 700x
Tube assembly:	White, 8.0" aluminum tube, baffled, flat black interior, engraved retaining ring, push-pull lens cell
Focuser type:	2.7" ID Astro-Physics rack & pinion focuser, 4.5" travel; 2" and 1.25" adapters; 2.5" extension
Telescope Length:	1524mm (60") with dewcap fully retracted
Weight with dewcap:	35 lbs. (15.9 kg)
Carrying case type:	Wood case with grey vinyl covering and foam lined interior
Case outside dimensions:	68"x12"x12" (173cmx30cmx30cm)
Weight of empty case:	32 lbs (14.5 kg)
35mm prime focus field:	0.9 x 1.3 degrees @ f9
35mm Telecompressor field:	1.3 x 1.9 degrees @ f6
35mm field with 2x Barlow:	0.4 x 0.6 degrees @ f18
6cm x 7cm Prime focus field:	2.2 x 2.5 degrees @ f9

Specifications subject to change without notice.

## FEATURES OF THE OPTICS

- Very high corrections of spherical and chromatic aberrations
- Textbook perfect diffraction patterns
- Visual and photographic focus is identical, eliminating the need for light absorbing filters
- Clear, colorfree glass types result in brighter, more contrasty images
- Stunning lunar / planetary and deep sky views
- Ideal for 35mm and medium format deep sky astrophotography
- High resolution optics are a great match for fine grained Technical Pan emulsions.

## FEATURES OF THE TUBE ASSEMBLY

- Felt lined dewcap slides over cell for storage
- Fully baffled tube and focuser assures highest contrast
- Giant 2.7" focuser allows coverage of 6 x 7 formats
- 2" and 1.25" adapters with brass locking ring, 2.5" extension
- Beautifully machined parts, expertly finished in hard polyurethane paint or black anodized
- Aluminum lens cover to protect against dust
- Sturdy foam padded carrying case

## SUGGESTIONS

- Mounting:
- 800 German Equatorial Mount with Dual Axis Drive
  - 54" Portable Pier

## Eyepieces:

Plossls, Orthoscopes, and Widefield eyepieces show sharp images only in the center of the field. These are fine as long as you realize this limitation. If you object to astigmatic images at the edge of the field, we recommend TeleVue Nagler and Panoptic eyepieces. These oculars have the best flat field images and will bring out the most in your 180 StarFire EDT. Use our 2" (2x) Barlow to double your magnification.

	magnification	actual field of view	exit pupil
55mm Plossl	29x	1.7 deg	6.2mm
35mm Panoptic	46x	1.5 deg	3.9mm
22mm Panoptic	74x	0.9 deg	2.4mm
13mm Nagler	125x	0.7 deg	1.4mm
9mm Nagler	180x	0.5 deg	1.0mm
7mm Nagler	231x	0.4 deg	0.8mm
4.8mm Nagler	338x	0.3 deg	0.5mm

Please refer to the brochure for descriptions of these items and additional accessories.



## ASTRO-PHYSICS

# Star130 and Star155 5.1" f8 and 6.1" f9 Super E.D. APOCHROMATS

Many experienced amateurs feel that the long focus doublet achromat does a superb job of showing the moon and planets with high contrast. Such achromats must be exceedingly long, f20 or longer, to reduce the visual color error to acceptable levels. With the Super E.D. (means Extra low Dispersion) lens design that we have developed, excellent color correction can be achieved in focal ratios as fast as f8. Compare the chromatic aberration (color error) of our Super E.D. doublet with Doublet Achromats and Fluorite Doublet Apochromats (see accompanying spot plots). The performance of the Super E.D. doublet objective is quite similar to that of the much more expensive Fluorite doublets, in fact, the color correction is so good that only an expert optician can tell them apart. Although normal E.D. glass has been available to the lens maker for a number of years, Super E.D. glass with a dispersion,  $V_d > 90$  has only recently been made in sufficient quantity for telescope refractor objectives. Super E.D. doublet lenses can be corrected for spherical aberration over a wider wavelength range than normal E.D. lenses. We invest a little more for premium materials to insure that you achieve the absolute best definition and contrast that can be obtained with a doublet objective.

The optical design of the Super E.D. objective consists of a flint leading doublet with the E.D. glass in the rear of the objective. The design is free of coma, spherical aberration and other higher order aberrations. All surfaces are spherical, which results in a very smooth overall figure. Under steady viewing conditions, you will see a sharply focused Airy disc surrounded by the first diffraction ring. Inside and outside of focus you will see an evenly illuminated, expanded disc with concentric Fresnel rings, with the outermost ring brighter and wider than the rest. The objective settles down quickly, rarely taking more than 30 minutes to reach thermal equilibrium. Like our EDT triplet objectives, we have tested the performance of the Super E.D. doublet objectives in sub zero temperatures and have found them to perform perfectly under those conditions.

### MECHANICAL CONSTRUCTION

All aspects of the tube assembly and carrying case are identical for our line of Super E.D. Doublets and EDT Triplet refractors. The dewcap slides over the lens cell for more compact storage. An aluminum dust cover protects the optical surface when not in use, and a foam fitted carrying case will help retain the beauty of your tube assembly for years to come. The tube is fully baffled, painted with light absorbing flat black and features our adjustable push-pull cell.

Our superb Astro-Physics focuser is a very finely crafted unit with several unique features. The components are machined on our own CNC to extremely high tolerances assuring that there is no wiggle between the drawtube and housing. More than a dozen knife-edge baffles are machined into the wall of the drawtube and painted flat black in order to maximize contrast by essentially eliminating any internal reflections. The inside diameter (I.D.) of the drawtube is 2.7" which allows the avid astrophotographer to use a medium format camera to capture images in a 6x7cm format with minimal vignetting. 2" and 1.25" adapters allow you to use standard accessories. Recessed brass locking rings are installed at each thumbscrew location. As you tighten each thumbscrew, the brass locking ring clamps onto the part that has been inserted. Consequently, your focuser drawtube, 2" accessories and 1.25" accessories are held securely in place. This is particularly important considering the heavy and expensive accessories that you may use. As an added advantage, the brass will not mar the surface of your accessories. The focuser extension threads directly into the drawtube to provide an additional 2.5" of focuser travel for straight-through observations.



**Star130** Super E.D. Doublet, 400 mount, 48" Pier and  
**Star155** Super E.D. Doublet, 600 E mount, 54" Pier

### PERFORMANCE

The Super E.D. Doublet refractors are handcrafted with the same care as our E.D. Triplets. The spherical correction is superb over the red to violet visual wavelengths, allowing the observer to bring all the important colors to a critical focus. Planetary details are resolved crisply with good definition and contrast. Lunar craters appear white on black at high power, without the annoying blue haze normally seen in achromatic doublets. Under steady seeing conditions, powers of 100X per inch are quite practical without image breakdown. Even here the chromatic aberration effects are quite small. Double stars are split cleanly to the theoretical limit of 0.74 arc seconds. Star clusters appear extremely sharp at all powers, nebulae and galaxies are surprisingly bold and crisp with fine detail features easily missed in mass production telescopes. Our refractors are ideal for high resolution photography of the Sun's surface in Hydrogen alpha and white light. We will be happy to assist you in designing a first class solar observing system.

Our **STAR 130** and **STAR 155** Super E.D. refractors are built to the quality levels of world class instruments, yet are truly affordable to every serious amateur. They are both quite portable and set up easily in minutes on our rugged German Equatorial mountings. You will appreciate the attention to detail that sets these instrument apart from every other refractor on the market. They are supremely satisfying to use and to own.

## COMPARISON OF COLOR CORRECTION OF AMATEUR TELESCOPE OPTICS

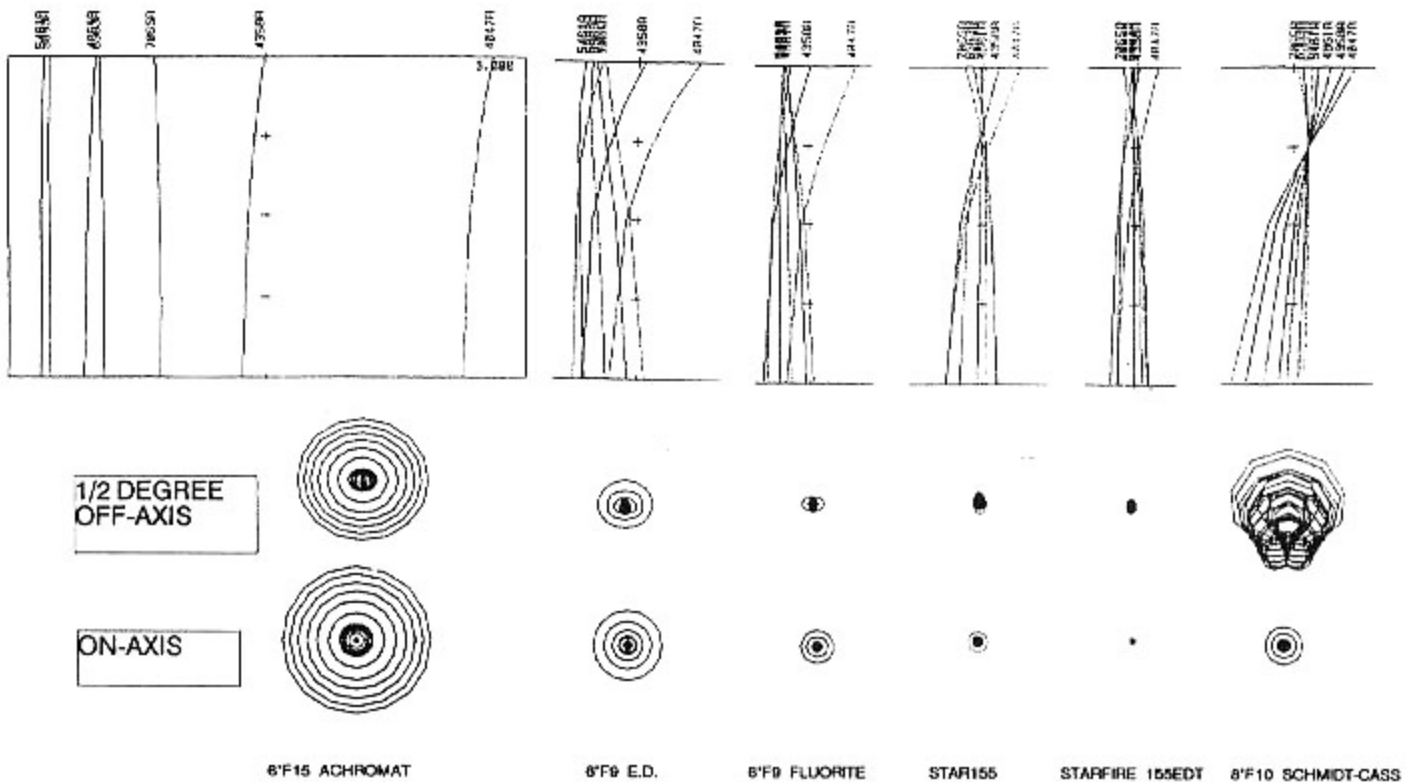

The above graphs and spot diagrams compare the color correction of six different optical designs. The graph shows the residual color error for 7 wavelengths from 7065A to 4047A at an approximate scale of 0.18 cm/cm for the achromat and 0.1 cm/cm for the rest of the optics. The spot diagrams were computer ray traced for three colors, 6563A, 5461A and 4358A. The on-axis spot diagrams show what you would expect to see when examining the image of a bright blue star at high power (~400 X). It is assumed that all optics are equally well figured to better than 1/10 wave in the yellow-green peak. The residual color errors shown above are strictly the result of the inherent limitations of the optical designs. The upper spots show the image at the edges of a 1 degree field, indicating the amount of field curvature and coma present in the objectives. The 6\"/>

### SPECIFICATIONS: STAR130 E.D.

Secondary Spectrum: Less than .01% 706 - 405nm.  
 Clear aperture: 130mm (5.1")  
 Focal Length: 1040mm (41")  
 Resolution: 0.88 arc seconds  
 Magnification range: 18x to 500x  
 Tube assembly: White, 5.5" aluminum tube, baffled, flat black interior, engraved retaining ring, push-pull cell  
 Weight with dewcap: 6.4 kg (14 lbs)  
 Carrying case type: Wood case with grey vinyl covering and foam lined interior  
 Case outside dimensions: 40.5"x9"x9" (103cmx23cmx23cm)  
 Weight of empty case: 15.5 lbs. (7.8kg)  
 35mm prime focus field: 1.3 x 2.0 degrees @ f8  
 35mm Telecompressor field: 2.0 x 3.0 degrees @ f5.3  
 35mm field with 2x Barlow: 0.7 x 1.0 degrees @ f16  
 6cm x 7cm Prime focus field: 3.4 x 4.0 degrees @ f8  
 Specifications subject to change without notice.

### FEATURES OF THE OPTICS

- Superb corrections of spherical and chromatic aberrations
- Extremely well corrected for visual and photographic work
- Clear, colorfree glass types result in brighter, more contrasty images
- Stunning lunar / planetary and deep sky views
- Excellent for 35mm and medium format deep sky astrophotography

### SPECIFICATIONS: STAR155 E.D.

Secondary Spectrum: Less than .01% 706 - 405nm.  
 Clear aperture: 155mm (6.1")  
 Focal Length: 1395mm (55")  
 Resolution: 0.74 arc seconds  
 Magnification range: 25x to 600x  
 Tube assembly: White, 6.5" aluminum tube, baffled, flat black interior, engraved retaining ring, push-pull cell  
 Weight with dewcap: 9.5 kg (21 lbs)  
 Carrying case type: Wood case with grey vinyl covering and foam lined interior  
 Case outside dimensions: 56.5"x9.8"x10.3" (144cmx25cmx26cm)  
 Weight of empty case: 22 lbs. (10kg)  
 35mm prime focus field: 1.0 x 1.5 degrees @ f9  
 35mm Telecompressor field: 1.5 x 2.2 degrees @ f6  
 35mm field with 2x Barlow: 0.5 x 0.7 degrees @ f18  
 6cm x 7cm Prime focus field: 2.5 x 2.9 degrees @ f9

### FEATURES OF THE TUBE ASSEMBLY

- Felt lined dewcap slides over cell for storage
- Fully baffled tube and focuser assures highest contrast
- Giant 2.7" focuser allows coverage of 6 x 7 formats
- 2" and 1.25" adapters with brass locking ring, 2.5" extension
- Beautifully machined parts, expertly finished in hard polyurethane paint or black anodized
- Aluminum lens cover to protect against dust

## 6"f9 STARFIRE TRIplet APOCHROMAT REFRACTOR

The Christen 6"f9 STARFIRE is a fantastic refractor that delivers the uncompromising performance of the classic long-focus instrument in a very compact and portable package. This telescope was designed on a challenge to deliver the absolute highest possible image quality for lunar/planetary observing while still remaining a truly portable instrument. The result is not only a fine planetary telescope, but also a superb deep sky instrument with unlimited photographic possibilities.

The heart of this system is a triplet lens design that virtually eliminates secondary color and higher order aberrations over the immense spectral range of 400nm to 700nm (from the edge of the U.V. to the Infrared region). The lens design incorporates two special dispersion flints that are matched to the hard crown front element. The image quality, contrast and color correction is so good that it is hard to believe one is looking through a short focus refractor. At high power, the Airy discs are clean white dots with only the minutest amount of violet visible on stars such as Vega and Sirius. The moon and planets appear totally color-free at all powers.

### SPECIFICATIONS:

Color correction : Less than .05% focus variation from 706nm to 405nm (r to h wavelengths)  
Clear aperture : 152mm (6")  
Focal length : 1372mm (54", + -1.5") efl  
Resolution: 0.74 arc seconds  
Magnification range : 25x to 600x  
Tube assembly : White, 6.5" aluminum tube, baffled, flat black interior, engraved push-pull lens cell  
Focuser type : 2.7" ID Astro-Physics rack & pinion focuser, 4.5" travel, 2" and 1.25" adapters, 2.5" extension  
Carrying Case : Foam fitted, vinyl covered plywood case  
Telescope length : 1279mm (50") with dewcap fully retracted  
Tube weight : 20 lbs.  
35mm Photographic field at prime focus : 1.0 x 1.5 degrees @ f9  
35mm Photographic field with Telecompressor : 1.5 x 2.2 degrees @ f6  
35mm Photographic field with 2x Barlow : 0.5 x 0.7 degrees @ f18  
6 x 7 cm Photographic field at prime focus : 2.5 x 2.9 degrees @ f9

## 6"f12 STARFIRE TRIplet APOCHROMATIC REFRACTOR

The StarFire design has proven so popular in the past few years that we decided to offer the 6"f12 StarFire for the most discriminating lunar/planetary observer. Color correction is essentially perfect, far exceeding that obtained in even the finest achromatic doublets. Planetary contrast is crisp and sharp showing exquisite detail and natural coloration on the surface. The planets themselves are well defined disks against a black sky. Low power performance of these long focal length lenses is equally impressive. Giant wide-field oculars will show star fields and deep sky objects with high contrast just like our faster lenses do. Astrophotography is possible at f8 with the triplet telecompressor. The barlow may be used for photo-visual work at f24, and even longer focal ratios are possible with the eyepiece projection adapter.

### SPECIFICATIONS:

Color correction : Less than .05% focus variation from 706nm to 405nm (r to h wavelengths)  
Clear aperture : 152mm (6")  
Focal length : 1829mm (72", + -1.5") efl  
Resolution: 0.74 arc seconds  
Magnification range : 33x to 600x  
Tube assembly : White, 6.5" aluminum tube, baffled, flat black interior, engraved push-pull lens cell  
Focuser type : 2.7" ID Astro-Physics rack & pinion focuser, 4.5" travel, 2" and 1.25" adapters, 2.5" extension  
Carrying Case : Foam fitted, vinyl covered plywood case  
Telescope length : 1727mm (68") with dewcap fully retracted  
Tube weight : 21 lbs.  
35mm Photographic field at prime focus : 0.8 x 1.1 degrees @ f12  
35mm Photographic field with Telecompressor : 1.1 x 1.6 degrees @ f8  
35mm Photographic field with 2x Barlow : 0.4 x 0.6 degrees @ f24

## 6" f7.5 STARFIRE EDF TRIPLET APOCHROMAT REFRACTOR

This 6" f7.5 StarFire EDF was designed to be the ultimate astrograph while providing uncompromising visual performance. Outstanding photographs published in *Sky & Telescope*, *Astronomy* and various international astronomy magazines can only hint at the detail of the original prints and negatives. The 30" x40" print of the Lagoon and Trifid nebula that is on display in our showroom shows incredible pinpoint star images from one side of the print to the other with no sign of image degradation. Truly amazing! Photographic spot diameters measure 15-20 microns over a 5 degree field (4" circle). The fast f7.5 focal ratio captures elusive and faint deep sky objects easily with incredible detail. This lens has outperformed mirror type astrographs twice its size, as we had predicted.

The EDF is superb as a visual instrument as well. It is easily capable of high power observations of the moon and planets. Secondary spectrum is totally absent at any power. Deep sky views are equally impressive due to the very high transmission of the three glass types.

In the astrographic configuration, the lens is a 5 element design in 2 groups (3 elements in front, 2 in rear). The heart of the front triplet is an E.D. glass and 2 special dispersion flints. This combination totally eliminates all secondary spectrum, coma and spherical aberration. The rear group is a 2 element field flattener system that eliminates astigmatism and field curvature. In the visual configuration, the rear 2 element lens is removed and replaced with a standard visual adapter. This adapter allows all our usual accessories to be attached, as well as all standard 2" and 1.25" oculars.

The tube assembly comes fully baffled for a 5 degree 4" field. The giant 4" focuser is silky smooth and can be locked for long time exposure astrophotography. Although it is possible to attach your own custom made film holder, we have determined that the most practical camera back is the Pentax 6 x 7 medium format camera. Field coverage is 3 x 3.5 degrees. After 4 years of field research, we've chosen this camera because it holds the film critically flat without the use of special vacuum attachments. This is not the case with other, less expensive film backs. The Pentax allows the user to critically focus directly on the ground glass with a high power magnifier, assuring the highest possible resolution. Another feature is the extra large opening and minimum back distance to the film plane which minimizes the inevitable vignetting of the light in the extreme corners of the format. All the important color and black/white films are available in the 120 format, which is not the case with large formats. It is for these reasons that we have standardized on the Pentax 6 x 7 and offer all the attachments necessary to use with the 6" EDF.

The Astro-Physics giant 4" focuser is truly versatile. The 4" ID of the drawtube will allow maximum coverage of the Pentax 6 x 7 cm negative for medium format photography. The inside of the drawtube has a series of knife edge baffles for maximum contrast. When you wish to use your 35mm camera with the Astro-Physics telecompressor for even faster exposures (f5), you can attach the 2.7" reducer and you are ready to go. The 2" and 1.25" adapters will allow you to use all of our standard accessories to maximize your visual and photographic applications.

### SPECIFICATIONS:

Color correction :	Less than .004% focus variation from 405nm to 706nm (r to h wavelengths)
Clear aperture :	152mm (6")
Focal length :	1143mm (45") efl
Resolution :	0.74 arc second
Magnification range :	20x to 600x
Tube assembly :	White, 6.5" aluminum tube, baffled, flat black interior, engraved push-pull lens cell
Focuser type :	4.0" ID Astro-Physics rack & pinion focuser, 4.5" travel, 2.7", 2" and 1.25" adapters, 2.5" extension
Telescope length :	1041mm (41") with dewcap fully retracted
Tube weight :	23 lb
Field Flattener	2-element with multi-coatings
Carrying Case	Foam fitted, vinyl covered plywood case
35mm Photographic field at prime focus :	1.0 x 1.7 degrees @ f7.5
35mm Photographic field with Telecompressor:	1.5 x 2.5 degrees @ f5
35mm Photographic field with 2x Barlow :	0.5 x .85 degrees @ f15
6 x 7 cm Photographic field at prime focus :	3.5 x 3.0 degrees @ f7.5
Maximum Photographic Field :	5 degrees, 4 inch circle

## STAR 12 ED APOCHROMAT REFRACTOR

We have developed an exciting new refractor based on a 2 element apochromat lens using a newly developed E.D. glass (E.D. stands for extra low dispersion) which has optical properties similar to Fluorite crystal. However, E.D. is real glass without the crystal planes of calcium fluoride materials that can absorb water in humid environments. E.D. glass is also a much harder and tougher material with a significantly lower coefficient of expansion. That means the lenses will stand up to years of use under all kinds of observing conditions. The lens design is a flint leading configuration with a very hard front element that will resist scratches from normal



Star 12 ED, Prototype 400 Mount, Small Davis & Sanford Tripod

cleaning. Both elements are stain and water resistant. The front element is fully anti-reflection coated. As in Fluorite objectives, the rear element is left uncoated because E.D. glass cannot be subjected to the extreme temperatures required to fuse the coatings to the surface.

Our Star12 ED refractor delivers the pinpoint sharpness, clarity and high definition demanded by the perfectionist, yet is priced to appeal to the beginning astronomer. Its light weight 11 lb. package is nicely balanced and fits well on small to medium sized mountings such as our model 600 or the DX mount. The lens is a true APOCHROMAT, capable of focusing the important visual wavelengths into the Airy disc. Visually on the moon and planets, there is little or no color fringing even at the highest powers. Both Jupiter and Saturn show a wealth of detail. Double stars such as Epsilon Bootes show a clean split with plenty of dark sky between.

We have included refinements such as our custom focuser with brass locking ring, engraved lens cell, fully baffled aluminum tube, and snappy decal identifying the telescope as an E.D. refractor from Astro-Physics.

### SPECIFICATIONS:

Color correction :	Less than 0.07% focus variation from 706nm to 405nm (r to h wavelengths)
Clear aperture :	120mm (4.7")
Focal length :	1016mm (40") efl
Resolution :	0.94 arc seconds
Magnification range :	18x to 470x
Tube assembly :	White, 5"aluminum tube, baffled, flat black interior, engraved lens cell
Focuser type :	2.7" ID Astro-Physics rack & pinion focuser, 4.5" travel, 2" and 1.25" adapters, 2.5" extension
Carrying Case	Foam fitted, vinyl covered plywood case
Telescope length :	1080mm (42.5") with dewcap in front of lens cell
Tube weight :	11 lbs.
35mm Photographic field at prime focus :	1.3 x 2.0 degrees @ f8.5
35mm Photographic field with Telecompressor :	2.0 x 3.0 degrees @ f5.7
35mm Photographic field with 2x Barlow :	0.7 x 1.0 degrees @ f17
6 x 7 cm Photographic field at prime focus :	3.4 x 4.0 degrees @ f8.5

# 400 GERMAN EQUATORIAL MOUNT

TIGHT, COMPACT, STRONG

SMOOTH, SOLID PERFORMANCE

The two most important considerations in mount design and construction are maximum strength/rigidity for a given size and accuracy of the drive system. Without this basic foundation, all other features of a mount are just superfluous frills. The Astro-Physics 400 Equatorial was engineered to be a compact, firm platform for your high resolution instrument. Whether your interests are purely visual or include astrophotography, a steady image in the eyepiece or camera viewfinder is extremely important.

The 400 is constructed of the highest quality components to provide you with years of observing pleasure. All parts are precisely machined on our computerized CNC using solid or thick wall aluminum and stainless steel. Machining tolerances are very high to achieve a tight, solid fit of all components. There are no thin wall, weak, porous die castings as in most other mounts of comparable size. We avoid the use of any carbon steel shafts or plated steel fasteners because they will deteriorate with time. This mount will not rust or bind up and will retain its appearance and function throughout the years.

Both axes respond to fingertip pressure with unparalleled smoothness. Built-in clutches can be disengaged for ultra-smooth sweeping or locked for astrophotography. The worm gears, motors and drive components are enclosed to protect them from dirt and dust. With the 105 Traveler, the 400 mount damps out in one second when mounted on the lightweight aluminum tripod.

Your 400 mount can grow with your skills and interests in astronomy. If manual slow-motion controls meet your visual astronomy needs at this time, you can begin with the basic mount, without motor drives, then add either the R.A. motor or both the R.A. and declination motors with the hand controller. If at all possible, we recommend that you purchase the R.A. motor so that the mount will follow the rotation of the earth. If you do not have any motors, you will be operating the slow motion controls continually to keep celestial objects in the center of the eyepiece. It is very difficult to concentrate on fine detail (surface markings of Mars, lunar rills, core stars of a globular cluster) if you must repeatedly adjust the mount. After all, fine resolution of these astronomical beauties is the reason that you purchased a high quality instrument!

When coupled with the options described separately, the 400 German Equatorial mount will be your portable observatory. This handy mount can be lifted easily into your backyard, packed conveniently into your car or carried aboard an airliner for travel to another hemisphere.

## FEATURES:

- Precision machined aluminum with radiused edges
- Gears and motors are fully enclosed
- Gear in declination axis allows full 360 degree continuous rotation: scope can move through zenith for photography
- 2.5" (6.4cm) hollow right ascension and declination shafts maximize strength at minimum weight
- Large UHMW thrust bearings form ultra-stable thrust surfaces for tremendous rigidity in a small package
- Right ascension shaft threaded for optional polar scope allows quick, accurate polar alignment in the field
- Removable stainless steel counterweight shaft for compact storage
- Engraved setting circles with Porter Slip Ring Design; polar axis ring is driven; it follows the stars without needing to be reset each time you look at a new object
- Fine altitude and azimuth adjustments for quickly and accurately zeroing in on the pole in the field
- Manual slow motion knobs in both axes
- Black anodized finish will retain its lustrous beauty for years

Worm wheel:	3", 192 teeth fine pitched bronze wheel stainless steel
Worm gear:	stainless steel
Tracking accuracy:	+/-5 arc second periodic error
Latitude range:	0-66 degrees
Azimuth adjustment:	approximately 25 degrees
Setting circles:	Porter Slip Ring design
Right ascension:	10 minute increments, pointer engraved both Northern/Southern
Declination:	1 degree increments, pointer
Capacity:	Will accommodate refractors up to 5" reflectors to 6", Cassegrains to 8"
Weight of equatorial head:	20 lbs (9.1 kg)

## RIGHT ASCENSION DRIVE - OPTIONAL

- High-resolution stepper motor in right ascension
- Electronics to drive at sidereal rate with 12 VDC power source
- Includes cords; does not include hand controller

## DUAL AXIS MOTOR DRIVE SYSTEM - OPTIONAL

- High-resolution stepper motors in both axes
- Lightweight, palm-sized controller
- Quartz control
- R.A. and declination reversing switches for correct object orientation and movement in eyepiece.
- Power output to plug in guiding reticle or other accessory
- Adjustable brightness control for guiding reticle
- Plug-in for SBIG ST-4 or ST-6 Star Tracker

Drive rates:	Sidereal, solar, lunar
Guiding/slewing rates:	2x/8x/16x
Hemisphere:	Switch for Northern/Southern
Power Consumption:	0.2 amps at normal rates
Power requirements:	12 VDC
Suggested power sources:	Portable battery pack, auto battery, power inverter for 110 volts

## OTHER AVAILABLE OPTIONS

Please see the accompanying information sheets for descriptions:

Sturdy, adjustable hardwood tripod with shelf and carrying case  
Lightweight Davis & Sanford aluminum adjustable tripod  
SBIG ST-4 or ST-6 CCD Star Tracker/Imaging System  
Portable Pier - 6" dia., heights 48", 54" or 62"  
6 Amp-hr, 12 Volt Rechargeable Battery Pack  
Stainless Steel Counterweights- 6 lbs., 9 lbs.  
Encoders for Digital Setting Circles  
Polar Axis Scope with Illuminator  
Mounting Rings  
Carrying Case

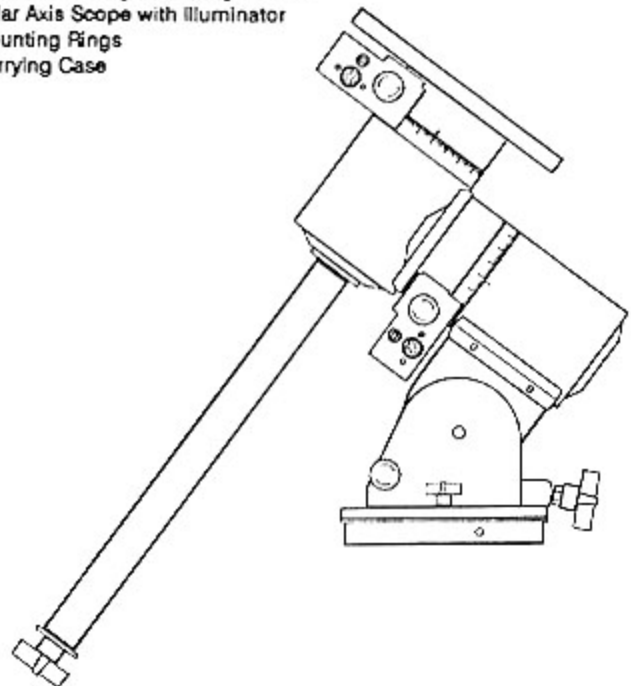

## 600 E GERMAN EQUATORIAL MOUNT WITH DUAL AXIS DRIVE

Astro-Physics 600 E German Equatorial mount offers many fine features to provide superb performance in a compact, portable package. It was engineered to provide a firm steady platform for your high resolution instrument. Both axes respond to fingertip pressure with no hint of backlash. Built-in clutches can be disengaged for ultra-smooth sweeping or locked for astrophotography.

The 600 E is constructed of the highest quality components to provide you with years of observing pleasure. All parts are machined of aluminum and stainless steel. We avoid the use of any carbon steel shafts or plated steel fasteners because they will deteriorate with time. This mount will not rust or bind up and will retain its appearance and function throughout the years.

Rigid aluminum castings enclose the worm gears and the right ascension and declination motors. Drive components are protected from dirt and dust; extraneous wires and gearing are eliminated and the overall appearance is enhanced.

Fine pitch, precision gears are the heart of the drive system. These gears are cut with Class AA hobbs on a highly accurate gear cutting machine. High resolution stepper motors deliver 150 inch-oz. torque with a fraction of the power required by normal synchronous motor-drive corrector systems. Designed for the utmost in convenience, this drive system operates from a portable battery pack or the cigarette lighter of your automobile.

Included in the hand control is a choice of drive rates for lunar, solar, sidereal and variable (handy for comets) tracking. A reversing switch for declination allows the 4 button controller to be properly oriented on both sides of the meridian. The fine-guiding rate is designed for accurate tracking of guidestars at very high powers. The slow rate can be used for leisurely cruising on the lunar surface or for rapidly centering objects in the field of view.

Over the years, our mounts and drive systems have functioned reliably in the coldest environments of Canada, Norway and remote Alaska. The circuitry of our controller has been proven since the mid 1970s and is comprised of the highest quality military spec components. We have seen many of our competitors' controllers constructed with flimsy, hygroscopic (water absorbing) circuit boards, components rated for indoor use, and poor solder connections. Astro-Physics controllers will stand up to the humidity and temperature extremes common to many observing locations.

When coupled with the options described separately, the 600 E will be your portable observatory for home or dark sky site. Within minutes, you will be assembled and polar aligned, ready to enjoy the wonders of the night sky.

### SPECIFICATIONS OF EQUATORIAL HEAD:

Worm wheel:	4" fine pitched bronze wheel
Worm gear:	stainless steel
Tracking accuracy:	+/-5 arc second periodic error
Latitude range:	15-57 degrees
Azimuth adjustment:	approximately 17 degrees
Setting circles:	Porter Slip Ring design
Right ascension:	10 minute increments, 2 minute vernier
Declination:	1 degree increments, pointer
Capacity:	Will accommodate refractors up to 6" f9, reflectors to 8", Cassegrains to 10"

Weight of equatorial head: 27 lbs (12.3 kg)

### SPECIFICATIONS OF MOTOR DRIVE SYSTEM:

Dimensions of controller:	4"x 3"x 1.5" inches
Drive rates:	Sidereal, solar, lunar, variable
Guiding/ Slewing rates:	2x/ 8x
Hemisphere:	Switch for Northern/ Southern
Power consumption:	0.25 amps at normal rates
Power requirements:	12 VDC
Suggested power sources:	Portable battery pack, auto battery, power inverter for 110 volts

### FEATURES:

- Virgin aluminum sand castings, precision hollow cast and machined for light weight and rigidity
- Gears and motors are fully enclosed
- Dual Axis Pulse Motor Drive with 12 Volt Controller
- Gear in declination axis allows full 360 degree continuous rotation: scope can move through zenith for photography
- Large UHMW thrust bearings form ultra-stable thrust surfaces for tremendous rigidity in a small package
- Hollow right ascension and declination shafts maximize strength at minimum weight
- Right ascension shaft threaded for optional polar scope for quick, accurate polar alignment in the field
- Removable stainless steel counterweight shaft for compact storage
- Engraved setting circles with Porter Slip Ring Design; polar axis ring is driven; it follows the stars without needing to be reset each time you look at a new object
- Fine altitude and azimuth adjustments for quickly and accurately zeroing in on the pole in the field
- Power output to plug in guiding reticle or other accessory
- High-resolution stepper motors in both axes
- 4 Push buttons arranged in east-west, north-south configuration
- Toggle switch for guiding or slewing in both axes
- Toggle switch for reversing declination buttons
- Adjustable brightness control for guiding reticle

### AVAILABLE OPTIONS

Please see the accompanying information sheets for descriptions:

Modification of hand controller for SBIG ST-4 Star Tracker

Portable Pier - 6" diameter with heights 48", 58" or 68"

SBIG ST-4 CCD Star Tracker/Imaging System

6 Amp-hr, 12 Volt Rechargeable Battery Pack

Stainless Steel Counterweights- 6 lbs., 9 lbs.

Modification for latitudes 0-15 degrees

Davis and Sanford Adjustable Tripod

Polar Axis Scope with Illuminator

Hexagonal Mounting Rings

Carrying Case

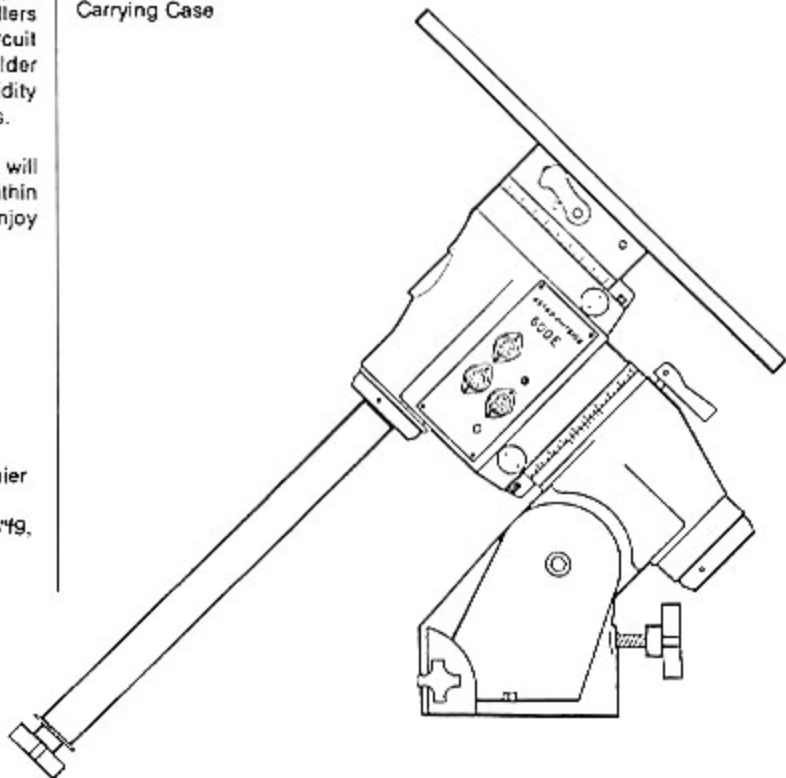

# 800 GERMAN EQUATORIAL MOUNT WITH DUAL AXIS DRIVE

The importance of mechanical stability in a mounting cannot be overstated. You may own a fine, high resolution instrument, but unless your mount is rock solid, you will rarely achieve the results that you want in the eyepiece or on film. The image will be subject to frequent movement, so you will not be able to perceive the subtlety of detail that would be possible if your image were steady. For astrophotography, movement in the image will result in a streak or blur on your negative.

Astro-Physics mountings are engineered to be steady even in gusting winds. Both axes respond to fingertip pressure with no hint of backlash. Built-in clutches can be disengaged for ultra-smooth sweeping or locked for astrophotography. The thrust bearing design allows for compactness, yet this mount will carry large telescopes with ease. Gear accuracy is also exceedingly important. Our gears were specifically designed for precision tracking. The fine pitch gears on our drives are cut with Class AA hobbs on a highly accurate gear cutting machine. With easy polar alignment capabilities, it is possible to take excellent astrophotos with minimal or no guiding with most telescopes.

Included in the hand control is a choice of drive rates for lunar, solar, sidereal and variable (handy for comets) tracking. A reversing switch for declination allows the 4 button controller to be properly oriented on both sides of the meridian. The fine-guiding rate is designed for accurate tracking of guidestars at very high powers. The slow rate can be used for leisurely cruising on the lunar surface or for rapidly centering objects in the field of view.

Over the years, our mounts and drive systems have functioned reliably in the coldest environments of Canada, Norway and remote Alaska. The circuitry of our controller has been proven since the mid 1970s and is comprised of the highest quality military spec components. We have seen many of our competitors' controllers constructed with flimsy, hygroscopic (water absorbing) circuit boards, components rated for indoor use, and poor solder connections. Astro-Physics controllers will stand up to the humidity and temperature extremes common to many observing locations.

When coupled with the options described separately, the 800 will be your portable observatory for home or dark sky site. Within minutes, you will be assembled and polar aligned, ready to enjoy the wonders of the night sky.

## SPECIFICATIONS OF EQUATORIAL HEAD:

Worm wheel:	6" fine pitched wheel
Worm gear:	stainless steel
Tracking accuracy:	+ -5 arc second periodic error
Latitude range:	0 - 57 degrees with polar scope in place
Azimuth adjustment:	
Setting circles:	Porter Slip Ring design
Right ascension:	10 minute increments, 2 minute vernier
Declination:	5 degree increments, 1 degree vernier
Capacity:	Will accommodate refractors up to 7", reflectors to 10", Cassegrains to 12"
Weight of equatorial head:	45 lbs (20.5 kg)

## SPECIFICATIONS OF MOTOR DRIVE SYSTEM:

Dimensions of controller:	4"x 3"x 1.5" inches
Drive rates:	Sidereal, solar, lunar, variable
Guiding/ Slewing rates:	2x/ 8x
Hemisphere:	Northern is standard Southern circles on request
Power consumption:	0.25 amps at normal rates
Power requirements:	12 VDC
Suggested power sources:	Portable battery pack, auto battery, power inverter for 110 volts

## FEATURES:

- Virgin aluminum castings, precision hollow cast and machined for light weight, yet provides rigid performance.
- Precision 6" Gear with + -5 sec periodic error.
- Dual Axis Pulse Motor Drive with 12 Volt Controller
- Manual slow motion knob in both axes
- Tangent arm in declination
- Massive tapered Timken roller bearings form ultra-stable thrust surfaces for tremendous rigidity in a small package.
- Hollow 1.5" stainless steel right ascension and declination shafts maximize strength at minimum weight
- Right ascension shaft threaded for optional polar scope for quick, accurate alignment in the field
- Removable 1.125" stainless steel counterweight shaft for compact storage.
- Polar and Declination axes come apart quickly for light-weight easy handling.
- Fine altitude and azimuth adjustments for quickly and accurately zeroing in on the pole in the field
- Engraved setting circles with Porter Slip Ring Design; polar axis ring is driven; it follows the stars without needing to be reset each time you look at a new object.
- Converts to an alt-azimuth mount for comet hunting and terrestrial viewing. Imagine, two mounts in one!
- When most scopes are mounted on our 8" diameter pier, they damp out in 1-2 seconds.

## AVAILABLE OPTIONS:

Please see accompanying information sheets for description

Modification of hand controller for SBIG ST-4 Star Tracker  
Davis and Sanford Adjustable Tripod for 6" f9 StarFire  
Right Ascension drive cord for Southern Hemisphere  
Portable Pier - 8" diameter with heights 48", 58", 68"  
6 Amp-hr, 12 Volt Rechargeable Battery Pack  
Stainless Steel Counterweights - 6 lbs., 9 lbs.  
SBIG ST-4 Star Tracker/ Imaging System  
Polar Axis Scope with Illuminator  
Hexagonal Mounting Rings  
Carrying Cases

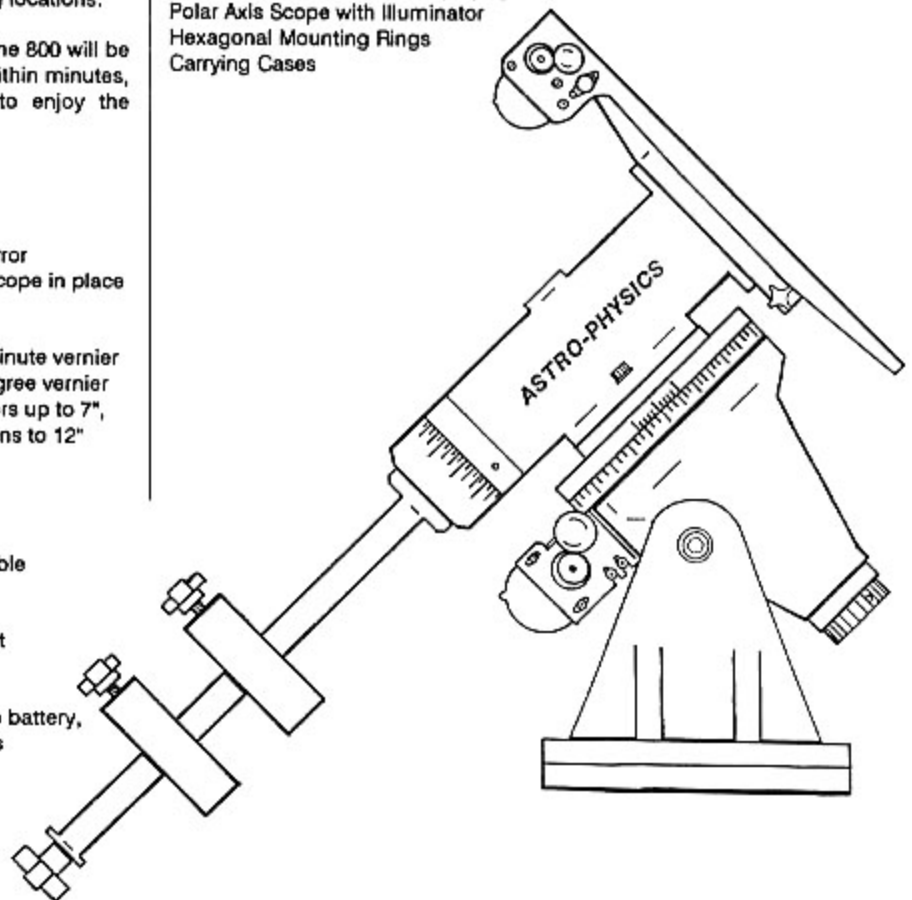



## ACCESSORIES FOR 400, 600 E AND 800 MOUNTS:

### SBIG ST-4 CCD STAR TRACKER/ IMAGING

If you plan to take long exposure astrophotos, we recommend the ST-4 from Santa Barbara Instrument Group (SBIG). It is a dual purpose CCD based instrument that functions as either a star tracker or imaging camera. The star tracker function is most exciting to us. The CCD detector is mounted on the focuser of your guide telescope or primary telescope (if using an off-axis guider). After you select the guide star that you wish to use, the ST-4 centers the image on a pixel and holds that star in position by constantly monitoring it and sending correction signals to the telescope drive immediately. Your right ascension or declination motors will then be activated automatically to make the appropriate corrections. All of this happens in split seconds, with greater accuracy than is possible with manual guiding.

Astro-Physics German Equatorial mounts are ideally suited for the ST-4. Since the gear accuracy is excellent ( $\pm 5$  arc second periodic error), only minor corrections are needed, mostly to compensate for slight inaccuracies in polar alignment. Beware of other mounts on the market that have significant amounts of backlash. Although the SBIG units can compensate for small amounts of backlash in declination, a long delay in reversal of direction (2 or more seconds) will reduce the ability of the unit to keep your guide star on target.

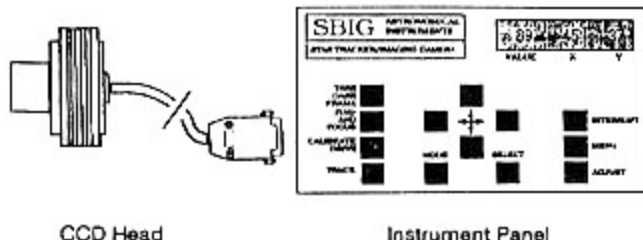

CCD Head

Instrument Panel

### MODIFICATION OF HAND CONTROLLER FOR SBIG ST-4 STAR TRACKER

Astro-Physics offers a modification for all of our German Equatorial mounts to integrate the function of the ST-4 with our hand controller. If you have ordered or plan to order one of our mountings, you may wish to consider the ST-4 modification which we can incorporate when building your hand controller. If you already own a 600 or 800 mount, we can retrofit your hand controller with this modification. Please give us a call so that we can plan our schedule accordingly.

Tony Hallas and many other customers have used the ST-4 extensively and are thrilled with its performance. Tony has remarked that his exposures of 60 minutes or more are a breeze because the human fatigue aspect is greatly reduced. Just think, after you set up your astrographic system and begin your exposure, you can take a break from the cold or mosquitos or enjoy visual astronomy with another scope. The SBIG will keep your guide star centered on the crosshair with amazing accuracy. We believe that this autoguiding capability will encourage more amateurs to take astrophotos with long exposures on fine grain film. You will be able to record fainter detail, denser nebulosity and eliminate guiding errors.

### PORTABLE RECHARGEABLE 12 V BATTERY PACK

The 6 amp portable battery pack is the ideal power source to have when you are observing in the field. Just plug the connector into the base of your mount to power your drives and electronic accessories. This unit is completely maintenance free, safe and can be operated in any position. The battery pack is easily recharged by the self-contained charger which inserts into the battery pack and plugs into a 110 wall outlet. Since it has no memory, it will recharge fully every time without a loss of capacity (unlike ni-cad batteries).

### HEXAGONAL MOUNTING RINGS

Astro-Physics mounting rings attach to the cradle plate of the mount and hold your tube assembly firmly in place. The unique hexagonal ring design allows you to support your guidescope, camera or other accessories requiring a flat mounting surface. These rings feature a hinged assembly with thumbscrew closure. They are felt-lined to prevent marring of your tube. The base of the mounting rings are drilled and tapped for 1/4-20 screws. The hole patterns fit the following mounts: Astro-Physics 400, 600E, and 800; Carton alt-azimuth; Vixen DX and Super Polaris; and the TeleVue Systems mount. The top of the rings are drilled for our piggyback camera bracket and guidescope rings. Please order the size that corresponds to the outside dimension of your tube assembly: 5.0", 5.5", 6.0", 6.5", 7.0", 8.0"

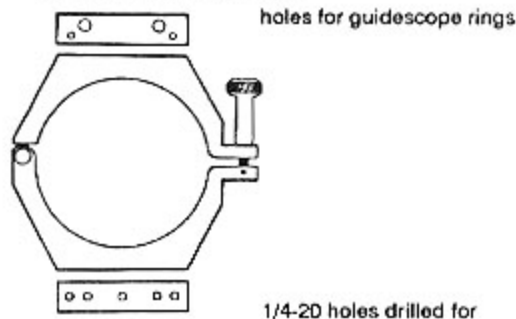

### POLAR AXIS SCOPE WITH ILLUMINATOR

The polar axis scope will allow you to quickly align your mount on the pole stars to ensure greater tracking accuracy throughout your observing session. The unit threads into the base of the polar axis of all Astro-Physics equatorial heads. The illuminator can be attached to the polar axis scope enabling you to see the reticle clearly. On-off control and adjustable intensity. Operates with batteries.

#### Specifications:

Magnification	5 x
Achromatic objective	20mm
Eyeiece	K22mm (Diopter adjustable)
Field of view	8 degrees
Rated Voltage	3VDC
Power consumption	16mA
Light	red LED
Battery	Button type: two Varta V76 PX or equivalent

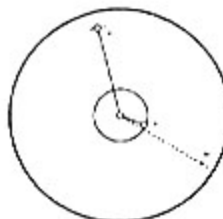
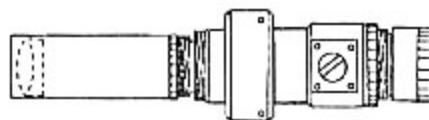

Reticle of polar axis scope

The secret to quick polar alignment is an easy to use reticle that shows the positions of several stars in the region of the polaris. Line up these stars in just minutes and you are ready to go.

## STAINLESS STEEL COUNTERWEIGHTS

Our counterweights are precision machined from 303 stainless steel. A bronze sleeve is press fit into the center hole to prevent marring of your counterweight shaft as you adjust the position of your counterweights. The weights slip easily onto the counterweight shaft and are secured in position with a large hand knob/brass pin assembly. The brass pin will not mar your shaft.

Keep in mind that you can adjust the position of the weights to counterbalance varying loads, however, the addition of a guidescope, camera and other heavy accessories may necessitate an additional counterweight. If you plan to mount your catadioptric, Newtonian or any other scope, figure that you will need a counterweight total approximately 80% of your tube assembly weight. We recommend the following combinations of weights for our refractors:

- 105 Traveler EDT Tube Assembly - one 9 lb. weight
- 130 ED Doublet Tube Assembly - two 6 lb. weight
- 130 StarFire EDT Tube Assembly - two 6 lb. weights
- 155 StarFire EDT Tube Assembly - two 9 lb. weights
- 155 ED Doublet Tube Assembly - two 9 lb. weights
- 180 StarFire EDT Tube Assembly - three 9 lb. weights
- 155 StarFire EDF Tube Assembly - two 9 lb., one 6 lb. weights

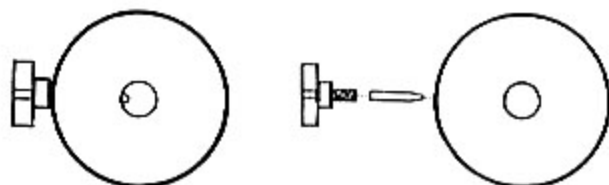

## 800 MOUNT CARRYING CASES

These carrying cases will allow you to transport your mounting in a protective and attractive manner. If you habitually organize your mount components in these cases, you will be sure to have all of your parts and tools when you arrive at your observing site. Please note that these cases were not designed for airline transport.

The polar axis, declination axis, cradle plate, hex rings and counterweight shaft all disassemble quickly for packing. The 800 mount is packed in a set of two vinyl covered cases. One case holds the polar axis assembly and the second case holds the declination axis with the cradle plate, mounting rings, hand control, power cords, polar axis scope and two counterweights and a few tools.

	dimensions L x W x H	weight of case w/o mount
800 Polar Axis Case	13" x 11" x 15"	14 lbs
800 Declination Axis Case	18" x 18" x 11"	16 lbs

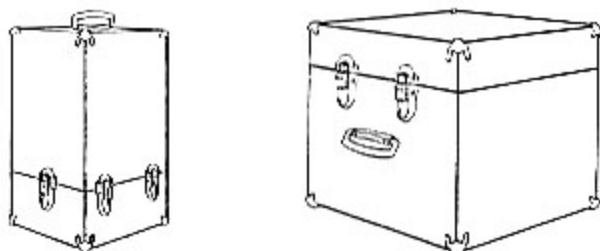

## 400 AND 600E MOUNT CARRYING CASES

The cases for these two mounts are constructed of molded ABS polycarbonate shell for strength and rigidity. These cases are suitable for airline baggage transport and can be locked using an external padlock (not provided). A pluckout foam interior allows you to customize your case.

	dimensions L x W x H	weight of case w/o mount
400 Mount Case	21.7" x 14.6" x 9"	10.7 lbs
600 E Mount Case	22.7" x 19.8" x 9"	13.4 lbs

## PORTABLE PIER

This pier mounting features a unique tension design that combines rugged construction with light weight while eliminating flexure and annoying vibrations. Legs and tension rods attach without hardware, allowing field assembly in seconds. Stainless steel tension rods do not interfere when the telescope is pointed at the zenith. Turnbuckles allow you to tighten the rods and are the secret to the firm base of support that this pier provides. The center posts are constructed of aluminum tubing, the base construction is aluminum and steel and the legs are steel.

### Pier for 600 E Mount

height of pier	48"	54"	682
diameter of post	6"	6"	6"
length of legs	24.5"	24.5"	24.5"
weight of pier post	7 lbs	8 lbs	9 lbs
weight of pier base	6 lbs	6 lbs	6 lbs
weight of each leg	5 lbs	5 lbs	5 lbs
weight of 3 struts	4 lbs	5 lbs	5 lbs
total weight assembled	32 lbs	33 lbs	34 lbs



### Pier for 800 Mount

height of pier	48"	54"	682
diameter of post	8"	8"	8"
length of legs	25"	25"	25"
weight of pier post	15 lbs	17 lbs	19 lbs
weight of pier base	11 lbs	11 lbs	1 lbs
weight of each leg	6.5 lbs	6.5 lbs	6.5 lbs
weight of 3 struts	4 lbs	5 lbs	5 lbs
total weight assembled	49.5 lbs	51.5 lbs	53.5 lbs

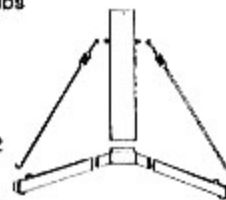

## DAVIS AND SANFORD TRIPOD

The adjustable Davis and Sanford (Tiffin) tripod is offered for light weight, compact transport. The legs retract and fold into a relatively small unit. It is recommended as the primary tripod for the 400 mount and 105 Traveler (or similar sized instruments). While it is not our first choice for the 400 mount and our 130mm refractors, it's a very portable option for people who plan to transport their equipment as airline baggage for observing in exotic locations (or on a business trip). This is the tripod that we transported by air to Baja, Mexico for the solar eclipse in 1991.

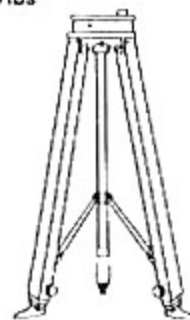

The tripod is constructed of black anodized aluminum and black painted aluminum castings.

Possible height:	29"-51"
Recommended height:	29"-45"
Weight:	11 lbs.
Maximum diameter:	6.5"
Minimum length:	34"

## ADJUSTABLE HARDWOOD TRIPOD

This superb hardwood tripod surpasses any portable tripod that we have seen anywhere. The unique method of attaching the legs to the tripod top was carefully engineered so that there is no side to side movement. Tripod comes with fabric carrying case.

Recommended height:	42"-55"
Weight:	18 lbs.
Maximum diameter:	6"
Minimum length:	45"

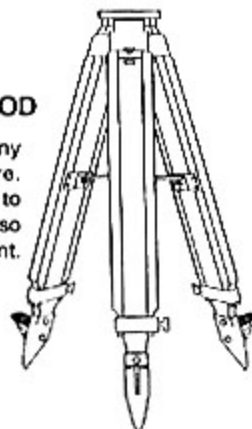

# ASTRO-PHYSICS ACCESSORIES

## ASTRO-PHYSICS 2.7" FOCUSER

For the amateur who wants a smooth, yet solid focuser, we manufacture our own model of high quality components. Our focuser features a drawtube of 2.7" inside diameter which allows the avid astrophotographer to use a medium format camera to capture images in a 2.25" x 2.25" format with minimal vignetting. A series of knife-edge baffles are machined directly into the drawtube to assure the highest possible contrast by minimizing reflections. The helical rack and pinion provides ultra-smooth motion for precision focusing. Our machined aluminum knobs were designed with comfortable, firm handling in mind. The adapter thumbscrews are substantial and easy to grasp.

Brass locking rings are an important feature of our focuser. We realize that many of our customers use a variety of heavy and expensive accessories including 2 lb. eyepieces, 35mm and medium format cameras, binocular viewers, etc. So, we designed our focuser with recessed brass locking rings at each thumbscrew location. As you tighten the thumbscrew, the brass locking ring clamps onto the part that has been inserted. Consequently, your focuser drawtube, 2" accessories and 1.25" accessories are held securely in place. As an added advantage, the brass will not mar the surface of your accessories.

This focuser is included with all of our StarFire refractors. The 2.7" focuser is also a first class choice for the do-it-yourselfer who takes pride in constructing his own tube assembly.

### FEATURES:

- All components are machined of high quality aluminum. Housing is black anodized.
- Brass locking rings to secure focuser drawtube, 2" and 1.25" accessories.
- 2" adapter is aluminum, black anodized, screws into focuser tube, brass locking ring, thumbscrew.
- 1.25" adapter is aluminum, black anodized, slips into 2" adapter or 2" diagonal, brass locking ring, thumbscrew, threaded for 48mm filters.
- Inside diameter of focuser draw tube is 2.7"
- Focusing travel with the 2" adapter is 4.4"
- Focusing travel with telecompressor is 5.0"
- Overall length of the focuser when fully racked in with 2" adapter is 4.8"
- Overall length of the focuser when fully racked in with 1.25" adapter is 5.25"

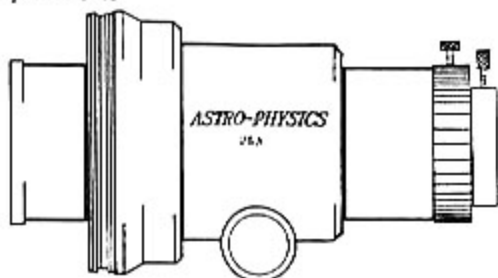

## FOCUSER EXTENSION

Our focuser extension tube threads securely into the focuser drawtube of the Astro-Physics 2.7" focuser and accepts the 2" adapter. A series of knife-edge baffles are machined into the wall. This extension will provide you with 2.5 additional inches of focuser travel necessary for straight through viewing. It is included with each focuser.



## 2" PHOTO-VISUAL BARLOW AMPLIFIER (2x)

This custom-made accessory doubles the focal length of the objective for high-power photo-visual observation. The 2-element design uses special glasses to preserve the fine color correction of the main objective. The optical elements are hand-corrected and precision centered to insure that no aberrations are introduced into the system. The large optics will accept both 1.25 and 2 inch

oculars and will cover a 2 inch photographic field with pinpoint images to the edge. Four baffles are machined into the barrel to eliminate internal reflections. The barlow also features a brass locking ring as described for the 2.7" focuser.

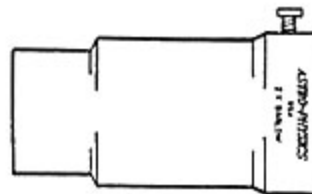

## FLAT FIELD PHOTOGRAPHIC TRIPLET TELECOMPRESSOR (0.67X)

Three elements of special optical glass are used to match the characteristics of our triplet objectives in this flat field design. The result is a telecompressor with diffraction-limited performance over the 35mm format. Deep sky objects are recorded in a fraction of the time needed at prime focus. This well corrected accessory lens preserves the high contrast and superb color correction of the main objective. A must for the serious astrophotographer. Threaded for 58mm filters. Please order either the 2" and 2.7" version depending on your focuser. Please specify the type of camera that you plan to use.

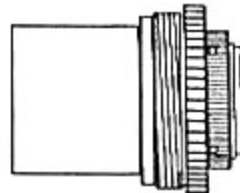

## CAMERA ADAPTER WITH T-RING FOR 35mm CAMERA

This camera adapter allows you to mount your 35mm camera to any focusing unit accepting 2" accessories for wide-field astrophotography. It is machined of aluminum and black anodized. The camera adapter is threaded for the popular 48mm filters. Please specify the type of camera you plan to use.

## CAMERA ADAPTER WITH EYEPIECE PROJECTION TELE-EXTENDER AND T-RING FOR 35mm CAMERA

You can use the camera adapter alone for prime focus astrophotography or insert your favorite eyepiece into the eyepiece projection tele-extender for achieve higher powers and closer views of your object. The assembly consists of a 2" prime focus camera adapter threaded for the popular 48mm filters, and a removable 1.25" eyepiece projection assembly with a brass locking ring to hold your eyepieces firmly in place.

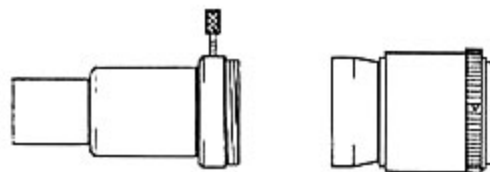

## PENTAX 6 x 7 cm CAMERA ADAPTER WITH FIELD FLATTENER

This accessory allows you to couple the medium format Pentax camera to your StarFire telescope for truly superb wide field photographs. The built-in field flattener lens produces sharp star images over the entire format. Enlargements of 16"x20" are possible without fuzzy images or loss of detail.

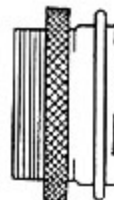

## ACCESSORIES

### 8x50 RIGHT-ANGLE OR STRAIGHT-THROUGH FINDERS WITH ILLUMINATED RETICLE

Our imported finders feature a unique eyepiece with crosshairs in the center of the field which can be illuminated with the matching self-contained, battery-powered LED. The 1.25" diagonal and eyepiece provide a wide field of view to assist you in locating your favorite objects.

Both finders are black and include a dustcover for the lens and a built-in dewcap. The right angle finder has a rubber eyecup and the straight through model includes a dustcover for the eyepiece. The rheostat control on the illuminator allows you to control brightness of the reticle. You will really appreciate the handy quick release finder bracket which is described below.

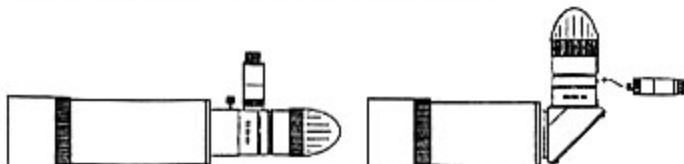

### QUICK RELEASE FINDER BRACKET

The quick release finder bracket was designed by Astro-Physics to make your life easier. Now, you can attach and detach your finder in seconds while retaining the alignment. The base of the bracket mounts onto the predrilled holes of your Astro-Physics refractor. The remainder of the assembly with the finderscope slips into the groove of the base bracket and tightens quickly with a thumbscrew. Now you are ready to go! There are no mounting screws to get lost in the grass or snow and your fingers won't freeze as you struggle with tools. The die cast mounting bracket includes fine adjustment screws with nylon tips to help protect the finish of the finder. This accessory is a must!

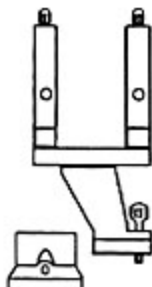

You may even want to consider the purchase of extra bases that you can mount permanently on your other telescopes. This will allow you to use the same bracket and finder interchangeably.

### 1.25" AMICI PRISM DIAGONAL

This right-angle diagonal contains a roof prism erecting system which allows normal orientation of the subject in your eyepiece. No more inverted or upside-down images! Terrestrial viewing is also more enjoyable when using the Amici or porro prism diagonal with your favorite eyepiece. Amici prism diagonals are not recommended for astronomical use.

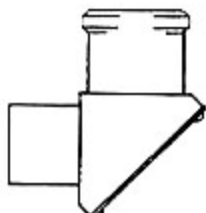

### 1.25" PORRO PRISM DIAGONAL

The porro prism diagonal provides straight-through viewing. Image orientation of the subject in your eyepiece is normal so it is easy to compare the star fields in your eyepiece with your star charts. Also recommended for daytime nature use of your refractor when straight-through viewing is preferred. Porro prism diagonals are not recommended for astronomical use.

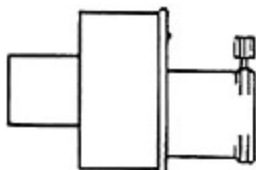

### 1.25" PRISM DIAGONAL

Right-angle diagonal prisms are fully coated and accept 1.25" eyepieces. Image orientation when used with a refractor is right side up with left/right reversal. Prism diagonals are not recommended for fast (f6) refractors.

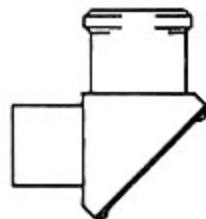

### 2" MIRROR DIAGONAL

If you own or plan to add the popular 2" widefield eyepieces to your collection, you will need a high quality 2" diagonal. This precision diagonal can also be used with 1.25" eyepieces when used with an adapter. Please note that while the adapter is NOT included with the purchase of the diagonal, you can either use the 1.25" adapter that is included with our 2.7" Astro-Physics focuser or purchase it as a separate item.

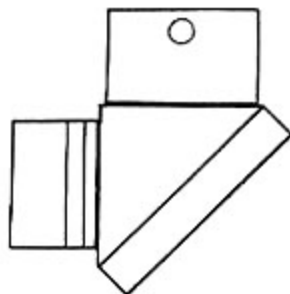

### PIGGYBACK CAMERA BRACKET

Attach this bracket to your favorite 35mm camera, then screw to the predrilled rings on the top of the hex rings. The unique micro-adjust knobs allow you to frame star fields easily in 2 axes.

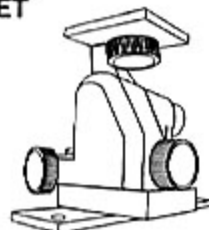

### 80 x 900 mm GUIDESCOPE

For serious astrophotography, a full 80mm (3") of aperture provides bright star images to facilitate guiding. Our imported guidescope includes a fine achromatic lens coupled with a smooth 1.25" helical rack and pinion focuser with a full 5.5" of travel. Two half-inch wide aluminum bands are attached to the optical tube in order to protect the finish from marring. The guidescope rings (4" I.D.) are mounted onto these aluminum bands and the three alignment thumbscrews are adjusted to position the scope. A dewcap and dustcover are included. You will need to purchase a 1.25" diagonal if you do not wish to view straight through. For manual guiding, we suggest a 12.5mm illuminated eyepiece and 3x barlow.

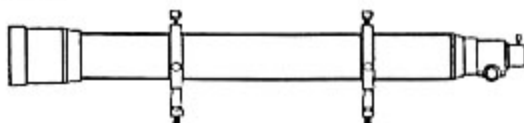

### 12.5mm ILLUMINATED EYEPIECE:

This 1.25" illuminated orthoscopic eyepiece will allow you to keep your guidestar in the center of your eyepiece. When illuminated, the crosshairs of this reticle stand out in stark contrast against the black sky allowing you to keep your star in the center of the field with ease. The etched glass double cross hair reticle includes a diopter adjustment to allow focusing of the eyepiece onto the reticle pattern. This feature compensates for individual eye variation. The self-contained battery unit provides a compact power supply. Standard filters can be used in the threaded barrel.

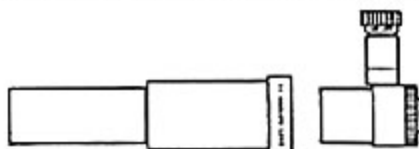

### 3x BARLOW:

Increase the power of your eyepiece with this 1.25" barlow. A great addition to your guiding equipment.

# Amateur Astronomers

Conducted by Stephen James O'Meara

## ADVENTURES IN REFRACTORLAND



**I**N my youth I spent many evenings enjoying two activities: snooker (a British billiard game) on cloudy nights and sky observing when it was clear. I still do. Under the snooker table in my games room, three telescopes await their turn under the stars.

The telescope I used most from age 16 to 21 was a Unitron 3-inch  $f/16$  equatorial refractor. In 1960 it cost me \$375, a year's savings from part-time and summer work at 55 cents an hour. Although Unitron refractors were standard equipment in the 1950's, today they have priced themselves right out of the market. I haven't even seen a 3-inch Unitron equatorial for almost a decade:

The 3-inch was a revelation compared to the flimsy 60-mm refractor I had started with in 1958. The Unitron was rock-steady with a thick hardwood tripod and silky slow-motion controls. It came with six eyepieces as standard equipment, though most of them were of simple design compared to eyepieces today. Star images in the 3-inch were tiny pinpoints. I recall splitting the "double-double" stars of Epsilon Lyrae at 48x. Lunar and planetary images were also superb; one night of excellent seeing (March 28, 1963), when Mars appeared only 10 arc seconds in diameter, I used 200x to see the planet's north polar cap and several surface markings, including the canal-like feature Xanthe. In retrospect, the optics and contrast efficiency had to be perfect to reveal that kind of detail.

Furthermore, the exceptionally long  $f/16$  focal ratio reduced chromatic aberration almost to zero. Only on Venus did a tinge of purple emerge. Today such performance is sometimes called apochromatic. I remember being shocked when I finally got to peek through bigger refractors and saw the violet haloes around Jupiter, Saturn, and brighter stars.

But I was even more dismayed by the erratic performance of the Newtonians used by most of my colleagues. Their telescopes ranged from a 6-inch  $f/10$  that produced pinpoint stars and excellent planetary detail to pitiful telescopes that could never be properly focused. At the time I was unaware of the devastating effects of improper collimation, tube currents, and large-aperture seeing limitations that plague Newtonians. I attributed it all to poor optics.

Regardless, that experience led me to purchase a larger refractor — a 7-inch  $f/17$  built by Harold Brown of Toronto. I bought it from a local amateur for \$200 in 1966; the owner regarded it as a white elephant and was glad to remove it from his garage. It had been used on a pier in the open for years, protected by a boat cover. The mount was, in effect, a rusted piece of yard sculpture. I could only salvage the counterweight. Likewise, the focuser was trash.

---

*Over the past 30 years,  
my observing started  
with refractors  
and has come full circle.*

---

A few months later, however, it came to life in my roll-off-roof observatory in suburban Toronto. The "Big Eye," as everyone called it, was the largest refractor in amateur hands in Canada. But as we all learn sooner or later in the backyard astronomy game, big isn't necessarily better. Anything moderately bright through the 7-inch was adorned with a purple wreath. The homemade objective also suffered from astigmatism. To eliminate most of it I had to diaphragm the objective to  $5\frac{1}{4}$  inches, which made it a fine  $f/23$  system. In any case, two years later a large shopping center was built about a mile away, greatly reducing the observatory's effectiveness. In 1969 I sold everything.

From 1970 to 1983 I purchased and sold a variety of Newtonians, Schmidt-Cassegrains, and Maksutovs. Although I enjoyed them all, none gave razor-sharp images like the old Unitron. I wasn't

about to return to small aperture. But why couldn't the performance of the 3-inch be scaled up to larger instruments? That bothered me.

Theoretically, an unobstructed optical system is the optimum design, and among amateur instruments available commercially that means the refractor. Furthermore, small imperfections in a lens' figure introduce far less aberration into the image than mirror defects. But the refractor's nemesis is chromatic aberration, which skyrockets as aperture increases. A 6-inch f/10 refractor has more than 30 times as much as a 3-inch f/15. To produce the same color-free images as the 3-inch, the 6 must have its chromatic affliction reduced by 97 percent.

In the late 1970's I heard about Takahashi's new fluorite refractors with exceptional color correction. More recently, other manufacturers have offered similar instruments. Fluorite, when used as one of the full-aperture elements in a doublet objective, eliminates false color to below the visual threshold, even on Venus. Four-inch models marketed by Takahashi and Celestron are superb performers — expensive but worth it for the purist. However, the cost of 5-inch or larger versions remains astronomical.

By 1984 another option had appeared on the scene: apochromatic refractors by

Illinois-based Astro-Physics. These telescopes have triplet objectives that virtually overcome chromatic aberration. In 1985 I ordered a 5-inch f/12. After my first night with that telescope, I knew the quest was over. Here was a telescope that acted like a scaled-up version of my old 3-inch Unitron. After a few months of observations with it, I couldn't resist ordering a family of three shorter focal ratio Astro-Physics refractors: a 4-inch f/6.5, 5½-inch f/7, and a 7-inch f/9.

---

*Apochromatic refractors  
offer a new level of  
observing experience  
for the purist with money.*

---

The 4- and 5½-inch refractors perform as well as the 5-inch f/12, though the former has a bit more residual color and the latter a shade less due to more exotic glass. Their shorter tubes make them excellent field telescopes. The 4-inch is particularly versatile atop a Celestron Super Polaris mount. It fits in my Firebird and can be set up in about three

minutes to provide perfectly framed views of the Pleiades at 20x or sharp images of the planets at 150x.

The 7-inch took 20 months to arrive, but it was worth the wait. The Astro-Physics design so effectively suppresses chromatic aberration it's as if the refractor has been reinvented. The Starfire series is virtually color-free. There remains a touch of false color that can be seen in stringent tests. For example, in my 7-inch a bit of spurious blue appears around Vega and a vague touch of blue around Venus. I have not seen chromatic aberration on other planets or the Moon.

Despite its low altitude from Canada, Saturn looked particularly impressive last year through the 7-inch. Cassini's division was obvious all the way around. I may have glimpsed Encke's too. Saturn's disk displayed several pale belts in addition to the conspicuous North Equatorial Belt, which contained some threshold detail. In the spring of 1988, gibbous Mars, only 9 arc seconds in apparent diameter, revealed a huge south polar cap, Syrtis Major, and Libya in average seeing. By opposition time the detail was overwhelming — more than I could draw. I was delighted to see, for example, the forking of Tithonus Lacus, which might represent detection of 75-mile-wide features on the planet.

In deep-sky tests, three experienced ob-

servers judged the 7-inch to be about equal to a good 10-inch f/5.6 Newtonian in showing faint objects. It was considered superior in revealing fine details such as dust lanes in galaxies and individual stars in the cores of globular clusters. At 180x the great cluster in Hercules (M13) became a mass of tiny stellar points. Planetary performance was no contest. And at 40x the 1°.6 field was stunning, framing the galaxies M81, M82, and NGC 3077 in Ursa Major beautifully.

Of course the comparison was partly unfair in that the refractor cost several times as much as the Newtonian. But it does demonstrate the several-inch advantage gained by unobstructed high-contrast optics that transmit about 97 percent of the light entering the lens.

The Astro-Physics refractors cost between \$300 and \$500 per inch of aperture (tube assembly only), which is less than some manufacturers charge for traditional refractors. Fluorites start at about \$400 per inch; some models are well over \$1,000 per inch. Tele Vue's Genesis refractor has a fluorite corrector only, and its performance is, I'm told by those who have tested it, comparable to true fluorites and the Starfires.

Yet why pay \$3,000 for an equatorially mounted 5-inch apochromatic refractor when you can get a fully loaded 8-inch Schmidt-Cassegrain or a 17-inch Dobsonian for the same outlay? Why, indeed?

Since this is a blatantly biased personal account, all I can write is why I have been smitten by apochromatic refractors. To me, telescope viewing is primarily an aesthetic experience — a private journey in time and space. Stars look like tiny pinpoints to the unaided eye, and that's the way I want my telescope to show them. Planets should appear as sharp-edged globes that focus to perfect clarity when the seeing is good. A faint star and a faint galaxy should always look completely different. In wide-field viewing the images should be in focus over the entire field.

Those are my (extremely high) criteria for a pleasurable observing experience. I don't want to see fuzz, flares, and waviness caused by mediocre optics or incessant tube currents. I want images as close to the real thing as possible. Now that I am seeing them in my new refractorland, I'm spending more time than ever at the eyepiece. You may not agree with my priorities. I expect that most amateur astronomers won't. Apochromatics aren't as compact as Schmidt-Cassegrains, nor can they compete with the brute aperture of large Newtonians. But they come closest to my idea of a perfect telescope.

---

Reprinted with permission of  
Sky Publishing

Mr. Dickinson is a former editor of Astronomy magazine. He has authored several books about astronomy:

- The Backyard Astronomer's Guide (with Alan Dyer, Camden House)
- Nightwatch (Camden House)
- Exploring the Moon and the Solar System Sky Guide (with Sam Brown, Camden House)
- Mag 6 Star Atlas (w/ V. Costanzo & G.F. Chaple, Edmund Scientific)
- Halley's Comet: Mysterious Visitor From Outer Space (Edmund Scientific)
- The Universe and Beyond (Camden House)
- Exploring the Night Sky (Camden House)
- Exploring the Sky by Day (Camden House)

Camden House Publishing Ltd.  
7 Queen Victoria Road  
Camden East, Ontario  
K0K 1J0  
Canada

Edmund Scientific  
101 E. Gloucester Pike  
Barrington, NJ 08007  
U.S.A.

TERENCE DICKINSON  
Box 10  
Yarker, Ont. K0K 3N0  
Canada